

A | B | C | D | E | F | G | H | I

REVISIONS				
ECN	REV.	DESCRIPTION	DATE	APPROVED

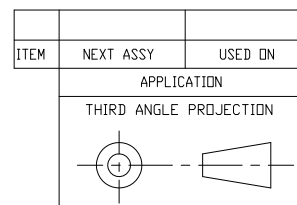
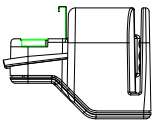
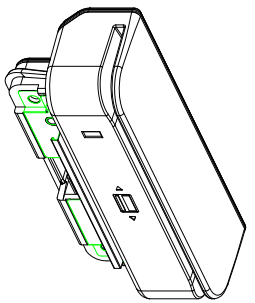
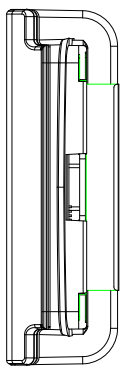
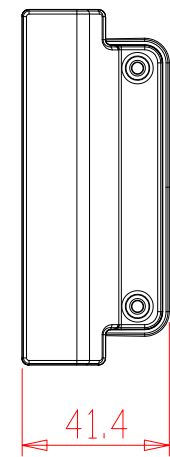
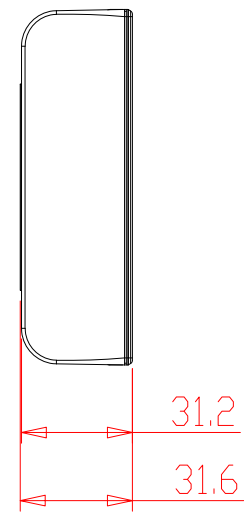
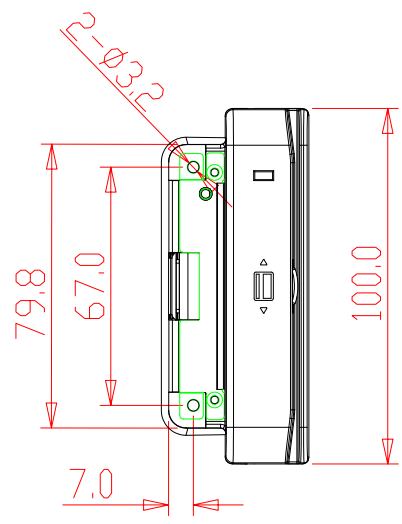
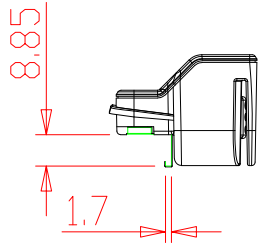

UNLESS OTHERWISE SPECIFIED DIMENSION ARE IN : M/M		THIS DRAWING(SPECIFICATION) IS THE PROPERTY OF TPK CORPORATION ALL RIGHTS RESERVED	
INCHES	METRIC	APPROVALS	DATE
.XX ±	0.X ±0.2	DRAWN: Tom	Mar-22-21
.XXX ±	0.XX ±0.1	CHECKED: Junco	Mar-22-21
ANGLES: ±1.0 °		ISSUED: Jackal	Mar-22-21
MATERIAL	COLOR	Scale	
DO NOT SCALE DRAWING		1 sheet of 1	

MICROTOUCH CONFIDENTIAL			
PART NAME			
MSR_MSR-156-A1			
SIZE	DWG. NO.	REV.	
A4	F81588111KIT	A	
Scale		0.500	