



USER MANUAL

---

# MEDICAL GRADE TOUCH MONITOR

DT-215P-M1



# Table of Contents

About This Document .....	4
Compliance Information .....	5
Important Safety Instructions .....	7
Usage Notice .....	7
Precautions.....	7
Installation Tips .....	10
Product Overview .....	11
Key Features .....	11
Unpacking.....	11
Package Contents .....	12
Product Setup and Use.....	13
Configuration and Cable Options.....	13
Turning Monitor On and Off .....	14
On-Screen Display (OSD).....	15
Locking the OSD and Power button functions .....	16
Using the OSD Menus .....	16
OSD Default Settings.....	22
Mounting options .....	23
VESA Mount .....	23
Stand Mount .....	24
Specifications and Dimensions .....	25
Specifications .....	25
Supported Timings.....	26
Dimensions.....	27

Appendix..... 29  
    Cleaning ..... 29  
    Solutions to Common Problems ..... 30  
    Warranty Information ..... 31  
    RoHS Declaration ..... 32

## About This Document

No part of this publication may be reproduced, transmitted, transcribed, stored in a retrieval system, or translated into any language or computer language, in any form or by any means, including, but not limited to, electronic, magnetic, optical, chemical, manual, or otherwise without prior written permission of MicroTouch™ a TES Company.

# Compliance Information

## For FCC (USA)

This equipment has been tested and found to comply with the limits for a Class B digital device, pursuant to part 15 of the FCC Rules. These limits are designed to provide reasonable protection against harmful interference in a residential installation. This equipment generates, uses, and can radiate radio frequency energy, and if not installed and used in accordance with the instructions, may cause harmful interference to radio communications. However, there is no guarantee that interference will not occur in a particular installation. If this equipment does cause harmful interference to radio or television reception, which can be determined by turning the equipment off and on, the user is encouraged to try to correct the interference by one or more of the following measures:

- Reorient or relocate the receiving antenna.
- Increase the separation between the equipment and receiver.
- Connect the equipment into an outlet on a circuit different from that to which the receiver is connected.
- Consult the dealer or an experienced radio/TV technician for help.

This device complies with part 15 of the FCC Rules. Operation is subject to the following two conditions: (1) this device may not cause harmful interference, and (2) this device must accept any interference received, including interference that may cause undesired operation.

## For IC (Canada)

CAN ICES-3(B)/NMB-3(B)

## For CE (EU)

The device complies with the EMC Directive 2014/30/EU and Low Voltage Directive 2014/35/EU

## Disposal Information

Waste Electrical and Electronic Equipment



This symbol on the product indicates that, under the European Directive 2012/19/EU governing waste from electrical and electronic equipment, this product must not be disposed of with other municipal waste. Please dispose of your waste equipment by handing it over to a designated collection point for the recycling of waste electrical and electronic equipment. To prevent possible harm to the environment or human health from uncontrolled waste disposal, please separate these items from other types of waste and recycle them responsibly to promote the sustainable reuse of material resources.

For more information about recycling of this product, please contact your local city office or your municipal waste disposal service.

# Renseignements relatifs à la conformité

## Pour la FCC (États-Unis)

Ce matériel a fait l'objet d'essais qui ont déterminé qu'il respectait les limites d'un appareil de classe B selon la partie 15 des règlements de la FCC. Ces limites sont établies pour assurer une protection raisonnable contre les parasites nuisant à une installation résidentielle. Ce matériel génère, utilise et peut émettre des ondes radio électriques, et lorsqu'il n'est pas installé et utilisé selon les instructions, peut causer des parasites nuisant aux communications radio. Il n'y a toutefois aucune garantie qu'il n'y aura pas de parasites dans une installation en particulier. Si ce matériel cause des parasites à la réception d'ondes radio ou de télévision, ce qui peut être déterminé en l'éteignant et en l'allumant, l'utilisateur est invité à essayer de corriger le problème des parasites par l'une ou l'autre des mesures suivantes :

- Réorienter ou déplacer l'antenne de réception.
- Augmenter la distance entre le matériel et la réception.
- Brancher le matériel dans une prise sur un autre circuit que celui où le récepteur est branché.
- Consulter le distributeur ou un technicien radio ou TV expérimenté pour des conseils.

L'appareil respecte la partie 15 des règlements de la FCC. Le fonctionnement doit respecter les deux conditions suivantes : 1) cet appareil ne doit pas causer de parasites et (2) cet appareil doit accepter tous les parasites reçus, notamment ceux pouvant causer un fonctionnement non voulu.

## Pour Industrie Canada

Norme canadienne NMB-3(B)

## Pour la CE (UE)

L'appareil respecte la directive 2014/30/UE relative à la compatibilité électromagnétique et la directive 2014/35/EU sur les limites de basse tension

## Informations sur l'élimination

Déchets d'équipements électriques et électroniques



Ce symbole sur le produit indique que, conformément à la directive européenne 2012/19/UE régissant les déchets d'équipements électriques et électroniques, ce produit ne doit pas être jeté avec les autres déchets municipaux. Veuillez éliminer vos déchets d'équipement en les remettant à un point de collecte désigné pour le recyclage des déchets d'équipements électriques et électroniques. Pour éviter d'éventuels dommages à l'environnement ou à la santé humaine dus à une élimination incontrôlée des déchets, veuillez séparer ces articles des autres types de déchets et les recycler de manière responsable afin de promouvoir la réutilisation durable des ressources matérielles. Pour plus d'informations sur le recyclage de ce produit, veuillez contacter votre mairie ou votre service municipal d'élimination des déchets.

# Important Safety Instructions

Before using this monitor, please read the user manual thoroughly to help protect against property damage and to ensure your personal safety and the safety of others.

Be sure to observe the following instructions.

For installation or adjustment, please follow the instructions in this manual and refer all servicing to qualified service personnel.

## Usage Notice



### Warning

To prevent the risk of fire or shock hazards, do not expose the product to moisture.



### Warning

Please do not open or disassemble the product, as this may cause electric shock.



### Warning

The AC power cord must be connected to an outlet with ground connection.

Please follow all warnings, precautions and maintenance as recommended in this user's manual to maximize the life of your unit.

*Do :*

Disconnect the power plug from AC outlet if the product is not going to be used for an extended period of time.

*Don't :*

Do not operate the product under the following conditions:

Extremely hot, cold or humid environment.

Areas susceptible to excessive dust and dirt.

Near any appliance generating a strong magnetic field.

## Avis d'utilisation



### Mise en garde

Pour prévenir les risques d'incendie ou d'électrocution, ne pas exposer le produit à l'humidité.



### Mise en garde

Prière de ne pas ouvrir ou démonter le produit, car cela pourrait entraîner l'électrocution.



### Mise en garde

Le cordon d'alimentation doit être branché à une prise pourvue d'une mise à la terre.

## Précautions

Veillez suivre toutes les mises en garde, précautions et entretiens recommandés dans ce manuel d'utilisation pour maximiser la durée de vie de votre unité.

### *À faire :*

Utiliser uniquement l'adaptateur d'alimentation prescrit pour votre appareil.

Débrancher l'appareil lorsqu'il n'est pas utilisé pendant une période prolongée.

### *À éviter :*

Ne jamais utiliser l'appareil dans les conditions suivantes :

des conditions environnementales extrêmes (chaud, froid ou humidité)

des endroits remplis de poussières et de saletés.

à proximité d'appareils produisant un fort champ magnétique



## Warnings

To turn off monitor power, press “Power” on the OSD (On-Screen Display) keypad on the right rear side of the monitor or on the optional wired remote if it is connected.

When turning off the monitor by pressing the POWER button, the main power of the monitor is not turned off completely.

To disconnect power completely, remove the power plug from the outlet.

**If any of the following occur, remove the power plug from the outlet immediately:**

the monitor is dropped; the housing is damaged; water is spilled onto or objects dropped inside the monitor.

**Failure to immediately remove the power plug may result in fire or electrical shock. Contact qualified service personnel for inspection.**

**If the power cord or plug is damaged or becomes hot, turn the monitor off, make sure the power plug has cooled down and remove the power plug from the outlet.**

If the monitor is still used in this condition, it may cause fire or electrical shock. Contact your dealer for replacement.

 **If any of the following occur, remove the power plug from the outlet immediately:**  
the monitor is dropped; the housing is damaged; water is spilled onto or objects dropped inside the monitor.  
**Failure to immediately remove the power plug may result in fire or electrical shock. Contact qualified service personnel for inspection.**

 **If the power cord or plug is damaged or becomes hot, turn the monitor off, make sure the power plug has cooled down and remove the power plug from the outlet.**  
If the monitor is still used in this condition, it may cause fire or electrical shock.  
Contact your dealer for replacement.

 **Si l'un des événements suivants se produit, débranchez immédiatement la fiche d'alimentation de la prise:** le moniteur est tombé; le boîtier est endommagé; de l'eau est renversée ou des objets tombent à l'intérieur du moniteur.  
**Si vous ne débranchez pas immédiatement la fiche d'alimentation, vous risquez de provoquer un incendie ou un choc électrique. Contacter le personnel de service qualifié pour inspection.**

 **Si le cordon d'alimentation ou la fiche est endommagé, ou devient chaud, éteignez le moniteur, assurez-vous que la fiche d'alimentation a refroidi et débranchez la fiche d'alimentation de la prise.**  
Si le moniteur est toujours utilisé dans cet état, il peut provoquer un incendie ou un choc électrique. Contactez votre revendeur pour le remplacement.

# Installation Tips

## No Touch Screen Drivers Required

MicroTouch Touch Monitors are plug and play when connected to Windows 7 or later Windows devices; Kernel 3.2 for most builds of Linux; Android 1.0 and most other modern Operating Systems. If you have a non-Plug and Play operating system, please refer to the Technical Support Section of [www.microtouch.com](http://www.microtouch.com) or contact MicroTouch Technical Support to inquire about driver support for your particular operating system.

## Things to avoid

Don't install in a high-temperature environment. Operating temperature: 0°C to 40°C (0°F to 104°F), storage temperature -20°C - 60°C (-4°F to 140°F). If the monitor is used in a high temperature environment or near any heat sources, the case and other parts may become distorted or damaged, resulting in overheating or electrical shock.

Don't install in a high-humidity environment.

Operating humidity: 20-90%

Don't insert the power plug into anything other than a grounded 100-240V AC outlet.

Don't use a damaged power plug or worn outlet.

The use of extension cords is not recommended.

The use of the power supply that comes with the MicroTouch product is strongly recommended.

Don't place the monitor on an unstable shelf or surface.

Don't place objects on the monitor.

If the monitor is covered or the vents are blocked, the monitor could overheat and cause a fire.

Please keep a 10 cm minimum distance between the monitor and the surrounding structures to allow sufficient ventilation.

Don't move the monitor when it is connected to the power cord and AV cables.

When moving the monitor, make sure to remove the power plug and cables from the outlet or source.

**If you encounter a problem during installation, please contact your dealer for assistance. Do not attempt to repair or open the monitor.**

# Product Overview

This medical grade desktop monitor is a wide format medical-grade monitor perfect for a wide range of healthcare applications.

## Key Features

Size: 21.5" TFT LCD

Resolution: 1920 x 1280

Contrast Ratio: 1000:1

Aspect Ratio: 16:9

Brightness: 297 cd/m<sup>2</sup>

View Angle: H: 178, V: 178

Video Port: 1 VGA (DB15), 1 HDMI, 1 DP

100 mm x 100 mm VESA mount

Front is sealed to IP54 standard

P-cap touch with up to 10 simultaneous touches







Plug and Play: no touch driver installation required for most modern operating systems

Warranty: 3 years

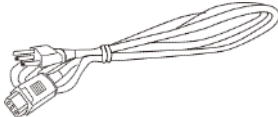
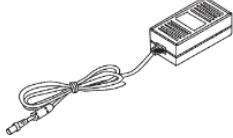
## Unpacking

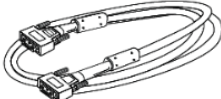
When unpacking please ensure that all the items in the following Accessories section are included. If any are missing or damaged, please contact the place of purchase for a replacement.

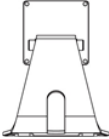
## Package Contents

No.	Part	Picture	Qty
1	LCD Monitor		1
2	AC Power Cord IEC C15/C16 (1.8m)		1
3	AC-dc adapter		1
4	HDMI Cable (1.8 m)		1
5	VGA cable (1.8 m)		1
6	USB A-B CABLE (1.8 m)		1
7	Stand		1
8	Cable Cover and Screw		1

# Product Setup and Use

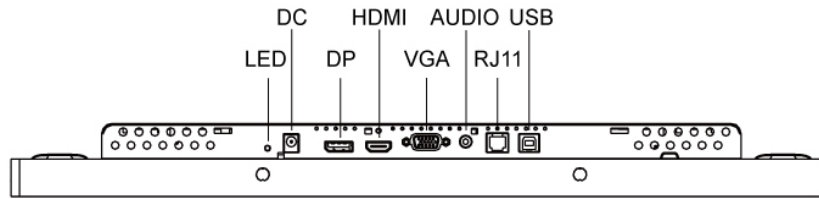

## Input and Output Connectors

### Power Connector

DC: Power connector (Center pin: + 12 volts DC; Barrel: ground).

### Video Signal Input Connectors

DP (Display Port): Digital video input.

HDMI: Digital video input.

VGA: Analog video input.

### Audio Signal Connector

AUDIO: Audio input.

### Optional OSD Remote Connector

RJ11: Connector for the on-screen display (OSD) remote controller, which is used to access the on-screen display menu to select the various options, and to turn the monitor on/off.

### Touch Output Connector

USB: Touch function output.

## Configuration and Cable Options

Power is supplied by the AC-to-DC power converter. Plug the DC barrel connector into the DC jack on the monitor. Plug the AC power cable female connector into the receptacle on the power converter, then plug the male connector of the AC cable into a wall outlet.

Connect the included USB cable from the monitor's touch output to the computer. To use the monitor's speakers, connect an audio cable from the computer into the AUDIO connector.

DP, HDMI and VGA video cables are included, and any of the three may be used to connect the video signal. Either DP or HDMI is preferred, as they are digital video signals. VGA may, in some cases, require some video setting adjustments.

## Turning Monitor On and Off

Turning the monitor On

Connect the monitor to DC power.

If the monitor does not come on within a few seconds, press the power button on the OSD keypad or the optional OSD wired remote.

When the monitor is on, pressing the Power button will open a pop-up that asks if the monitor is to be turned off. Press the Power button again to turn the monitor off.

**Note:** If there is no video input signal for a preset period, the monitor will automatically go into standby mode.

# On-Screen Display (OSD)

This monitor series provides OSD controls on the right rear side of the monitor, as viewed from the front, as outlined in red below. An optional wired OSD remote is also available.

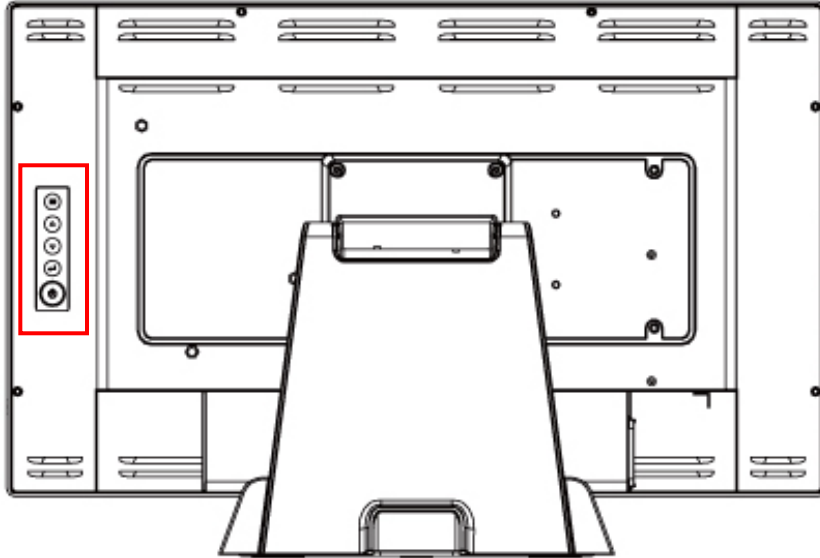

Button	Normal Video Display	When OSD Menu is Displayed
<b>MENU</b>	Activate the main menu	Exit selection / Exit OSD
<b>▲</b>	Brightness Adjust	Menu Up / Adjust Up
<b>▼</b>	Mute Audio	Menu Down / Adjust Down
<b>SELECT</b>	Select Video Source	Select the highlighted item
	Power on / Power off	

## Locking the OSD and Power button functions

**Lock OSD:** prevents all the monitor settings from being changed. When this function is activated, all OSD controls and hotkey operations will be disabled except for the Power button.

**Lock Power button:** Prevents monitor from being turned off by the Power button. The monitor will power on automatically when power is applied.

Either or both functions may be locked.

### To Lock/Unlock the OSD/Power buttons:

1. Press and hold Select for 5 seconds until the Lock menu appears, showing OSD “Active” (not locked) or “Inactive” (locked) and Power Active or Inactive.
2. Use the UP/Down buttons to highlight OSD or Power.
3. Press Select.
4. Use Up/Down buttons to select Yes or No (to change the setting).
5. Press Select.
6. The menu will go away after a few seconds and the selected item will lock if unlocked or unlock if locked, or Menu can be pressed to exit and take effect immediately.

## Using the OSD Menus

Navigating through the Menu System

With the power on, press **MENU** and the **on-screen menu** will pop up.

Within the menu, use ▲, ▼ and **SELECT** to navigate through the menus and adjust options.

Press **MENU** to return to the previous menu or exit the OSD menu

The OSD menu will automatically close if left idle for a pre-set time.



## Picture Menu

This menu is used for making common image adjustments. Note that some of the adjustments may be grayed out, indicating that they are not selectable. This indicates the use of a digital video input signal (DP, HDMI or USB Type-C). These selections are fixed/not adjustable for digital video signals. The VGA video signal (because it is analog) may require all adjustments, so they are all selectable when VGA is being used.

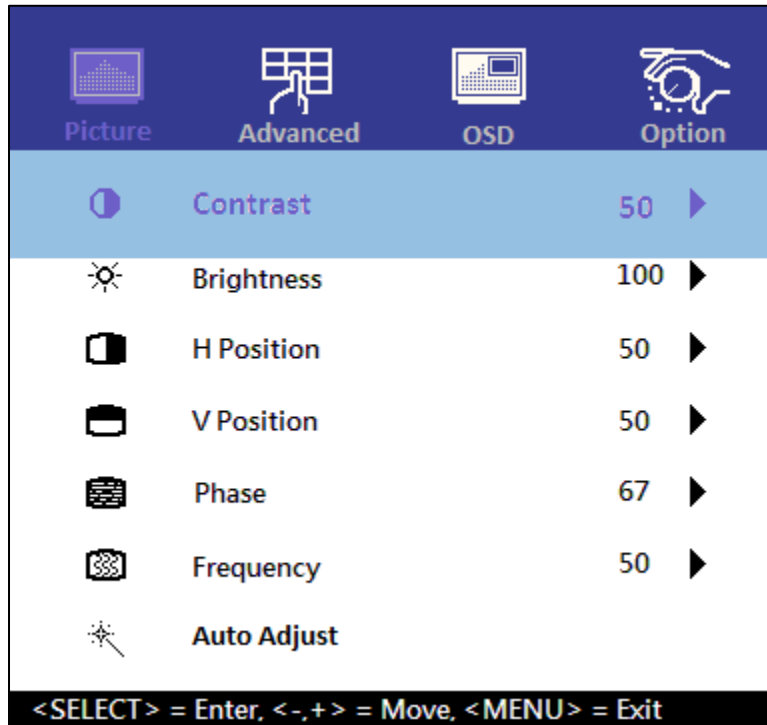

### Contrast

Increases or decreases the contrast of the picture. Press ◀ or ▶, select the desired level, and then press **SELECT**.

**Range:** 0-100

### Brightness

Increases or decreases the brightness of the picture. Press ◀ or ▶, select the desired level, and then press **SELECT**.

**Range:** 0-100

### H-Position

Adjust the horizontal position of the picture. Press ◀ or ▶ to select the desired level, and then press **SELECT**. Selectable only when VGA input is in use.

**Range:** 0-100

## V-Position

Adjust the vertical position of the picture. Press ◀ or ▶ to select the desired level, and then press **SELECT**. Selectable only when VGA input is in use.

**Range:** 0-100

## Phase

Adjust the pixel phase of the picture. Press ◀ or ▶ to select the desired level, and then press **SELECT**. Selectable only when VGA input is in use.

**Range:** 0-100

## Clock

Adjust the horizontal dot of the picture. Press ◀ or ▶ to select the desired level, and then press **SELECT**. Selectable only when VGA input is in use.

**Range:** 0-100

## Auto Adjust

Adjust and fine-tune the image to full screen automatically. Selectable only when VGA input is in use.

## Advanced Menu

This menu is used to adjust color temperature and image sharpness.

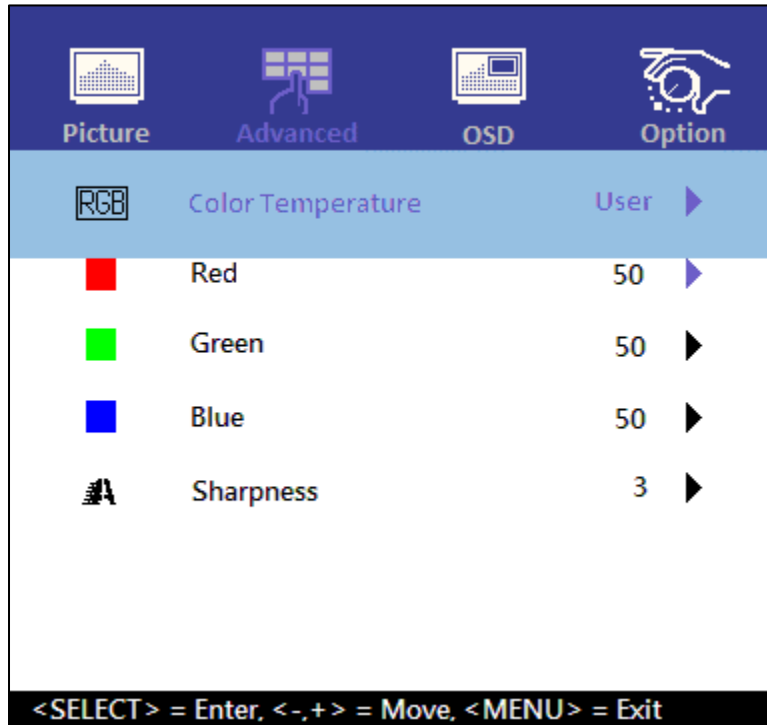

### Color Temp

Select the color temperature

**Options:** 5500K, 6500K, 7500K, 9300K, User

### Red

Adjust the amount of red in color content

**Range:** 0-100

### Green

Adjust the amount of green in color content

**Range:** 0-100

### Blue

Adjust the amount of blue in color content

**Range:** 0-100

### Sharpness

Adjusts the definition of the picture. Press ◀ or ▶, select the desired level, and then press **SELECT**. Selectable only when VGA input is in use.

**Range:** 0-50

## OSD Menu

This menu is used to make set-up adjustments to the OSD itself, as well as other on-screen messages.

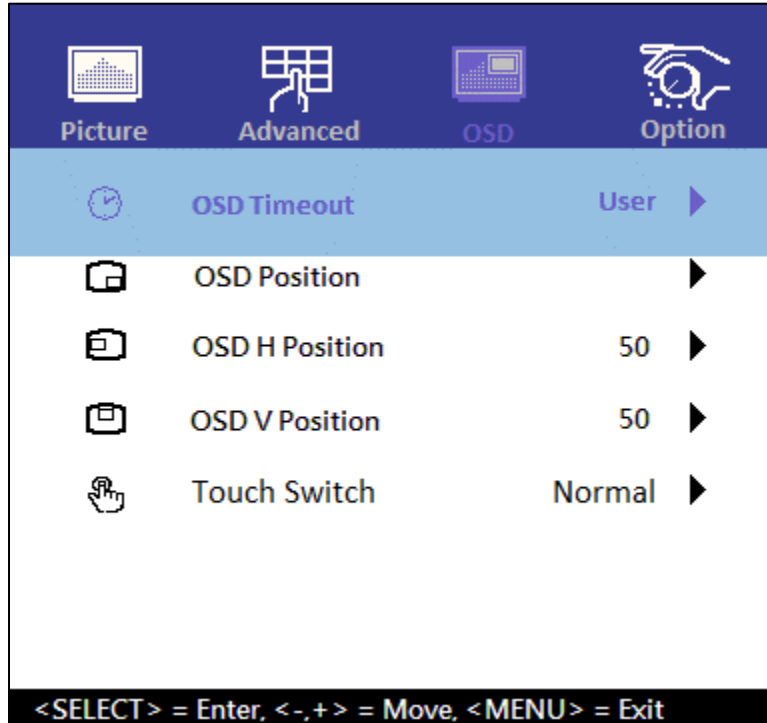

### OSD Timeout

Adjusts the time in seconds before the OSD menu disappears after no usage.

**Range:** 0-60 sec

### OSD Position

Selects the OSD Position (center or corners). Press ◀ ▶ to select the rotation.

**Options:** Top Left, Bottom Left, Top Right, Bottom Right, Center

### OSD H-Position

Adjusts the horizontal position of the OSD menu. Press ◀ or ▶ to select the desired horizontal position, then press **SELECT**.

**Range:** 0-100

### OSD V-Position

Adjust the vertical position of the OSD menu. Press ◀ or ▶ to select the desired vertical position, then press **SELECT**.

**Range:** 0-100

## Option Menu

This menu is used select or display various functions.

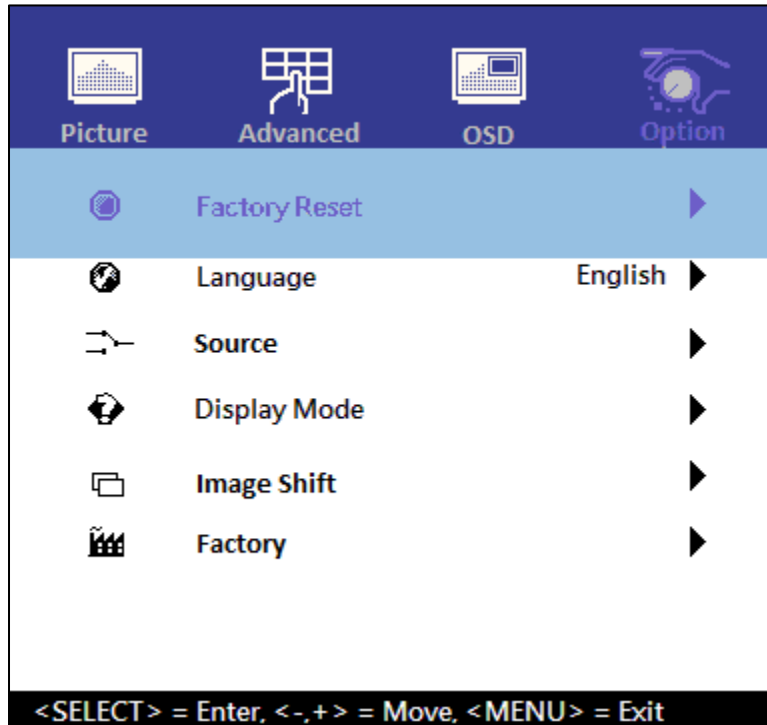

### Reset

Restore the factory default settings.

**Options:** Yes, No

### Language

Select the OSD language

**Options:** English, French, Deutsch, Italian, Spanish, Japanese, Traditional Chinese and Simplified Chinese

### Source Select

Select the Video Input Source

**Options:** Auto, VGA, HDMI, DP

### Display Mode

Display the current video source and resolution information.

### Factory

Enter factory mode

**This is only for maintenance service only. Do not use this function.**

## OSD Default Settings

Note: N/A applies when a digital video input (DP or HDMI) is in use

Menu	Parameter	Default Settings
<b>Picture</b>	Contrast	50
	Brightness	100
	H-Positon	N/A
	V-Positon	N/A
	Phase	N/A
	Clock	N/A
	Auto Adjust	N/A
<b>Advanced</b>	Color Temp	User
	Sharpness	50
<b>OSD</b>	OSD Timeout	15
	OSD Positon	User
	OSD H-Positon	50
	OSD V-Positon	50
<b>Option</b>	Reset	N/A
	OSD Language	English
	Source Select	Auto
	Display Mode	N/A
	Factory	N/A

## Mounting options

The monitor may be mounted to a stand or other device that has a 100mm x 100mm standard VESA mount hole pattern.

### VESA Mount

The monitor has an integral VESA standard mount pattern that conforms to the “VESA Flat Display Mounting Interface Standard” which defines a physical mounting interface and corresponds to the standards for monitor mounting devices.

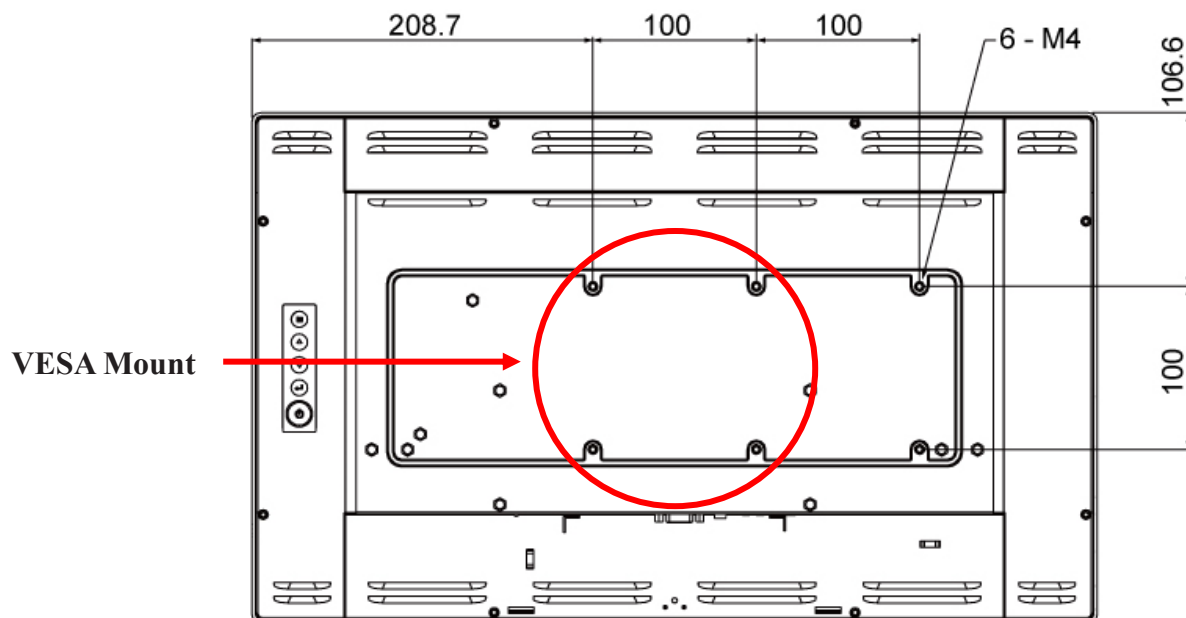

#### Warning

Please use the correct screws! The distance between the back cover surface and the bottom of the screw hole is 8 mm. Please use four M4 diameter screws with 8 mm length to mount the monitor.

#### Mise en garde

Veuillez utiliser les vis correcte! La distance entre la surface du capot arrière et le fond du trou de vis est de 8 mm. Veuillez utiliser quatre vis de diamètre M4 d'une longueur de 8 mm pour monter le moniteur.

## Stand Mount

This monitor may be mounted to a stand using the VESA mount pattern. A MicroTouch optional stand is recommended – see the Accessories section of the MicroTouch web site.

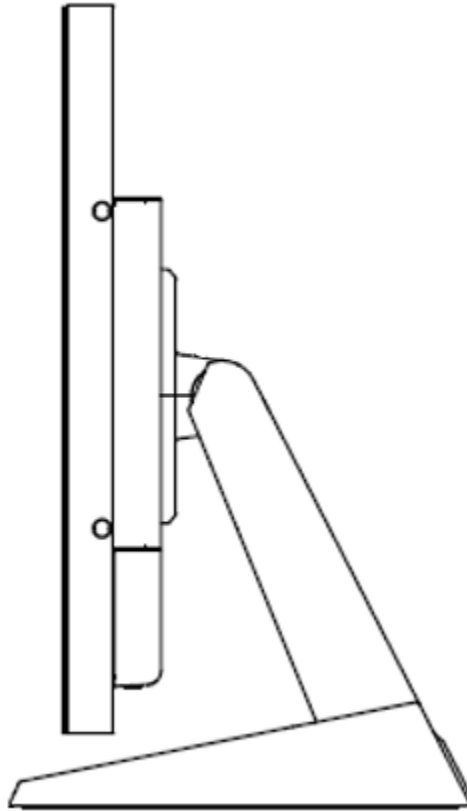



# Specifications and Dimensions

## Specifications

Item	Category	Specifications
<b>LCD Panel</b>	Size	21.5" TFT LCD
	Resolution	1920 x 1280
	Brightness (typical)	297 cd/m <sup>2</sup>
	Contrast Ratio (typical)	1000: 1
	Number of Colors	16.7 million
	Viewing Angle (typical)	Horizontal: 178 degrees; Vertical: 178 degrees
<b>Touch Screen</b>	Touch Type	P-CAP
	Simultaneous touch points	Up to 10
<b>Video</b>	Type	DisplayPort 1.2a HDMI 1.3 (Compatible with HDMI 1.4) VGA
<b>Power</b>	AC Adapter Input	AC 100V - 240V (50/60Hz), 60W max
	AC Adapter Output	12Vdc, 5A max
	Monitor On	27W typical, 30W max (2.25A typ, 2.5A max)
	Power Saving	Sleep mode: ≤ 1W; Off: ≤ 0.5W
<b>Size and Weight</b>	Dimensions (W x H x D) Without Stand	517.4 mm x 313.3 mm x 46 mm 20.37 in x 12.34 in x 1.82 in
	Dimensions (W x H x D) With IS-000-A1 Stand	517.4 mm x 351.7 mm x 219 mm 20.37 in x 13.85 in x 8.63 in
	Net Weight	5.5 kg without stand, 7.8 kg with IS-000-A1 stand 12.13 lb without stand, 17.20 lb with IS-000-A1 stand
	VESA Mount	100 mm x 100 mm
	<b>Environment</b>	Compliance
	Front seal	IP65
	Operating Temperature	0°C - 40°C
	Storage Temperature	-20°C - 60°C
	Operating Humidity	20% - 90% RH, non-condensing

## Supported Timings

Mode	Resolution	H-Freq. (KHz)	Bandwidth (MHz)	Polarity	
				H	V
1	720 x 400 @ 70 Hz	31.47	28.322	-	+
2	640 x 480 @ 60 Hz	31.47	25.175	-	-
3	640 x 480 @ 66 Hz	35	30.24	-	-
4	640 x 480 @ 72 Hz)	37.86	31.5	-	-
5	640 x 480 @ 75 Hz	37.5	31.5	-	-
6	800 x 600 @ 56 Hz	35.16	36	+	+
7	800 x 600 @ 60 Hz	37.88	40	+	+
8	800 x 600 @ 72 Hz	48.077	50	+	+
9	800 x 600 @ 75 Hz	46.875	49.5	+	+
10	832 x 624 @ 74.55 Hz	49.722	57.28	-	-
11	1024 x 768 @ 60 Hz	48.363	65	-	-
12	1024 x 768 @ 70 Hz	56.476	75	-	-
13	1024 x 768 @ 75 Hz	60.02	78.75	+	+
14	1280 x 1024 @ 60Hz	64	108	+	+
15	1280 x 1024 @ 75Hz	80	135	+	+
16	1152 x 864 @ 75Hz	67.5	108	+	+
17	1280 x 960 @ 60Hz	60	108	+	+
18	1440 x 900 @ 60Hz	56	106.5	-	+
19	1440 x 900 @ 75Hz	70.6	136.75	-	+
20	1680 x 1050 @ 60Hz	65.2	146	-	+
21	1680 x 1050 @ 75Hz	82.3	187	-	+
22	1280 x 768 @ 60Hz	47.776	79.5	-	+
23	1920 x 1080 @ 60Hz	67.5	148.5	+	+

# Dimensions

## Front view

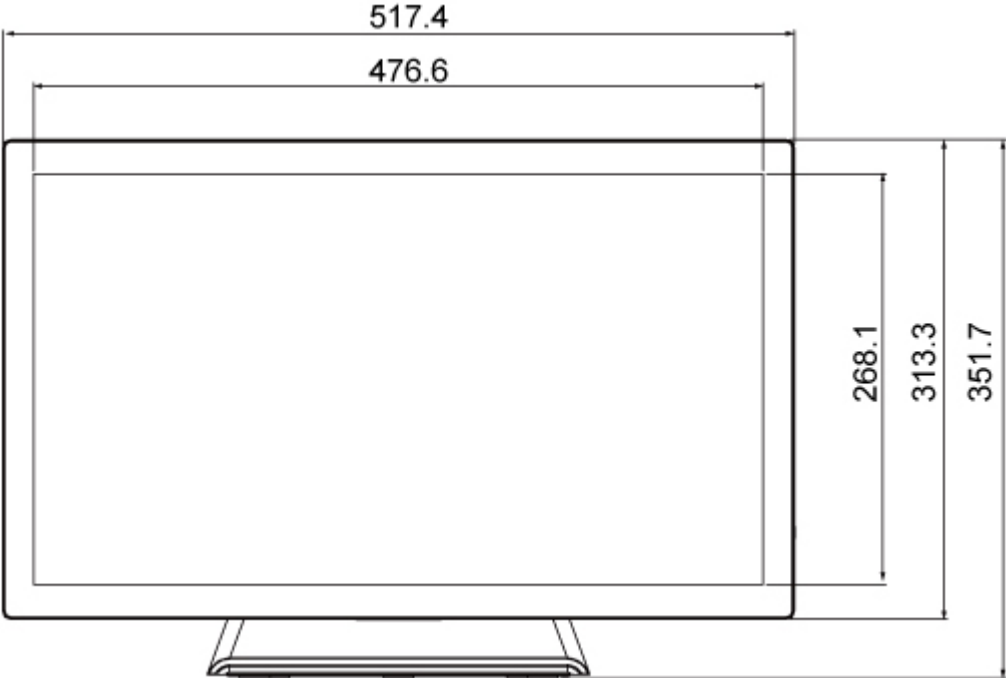

## Side View

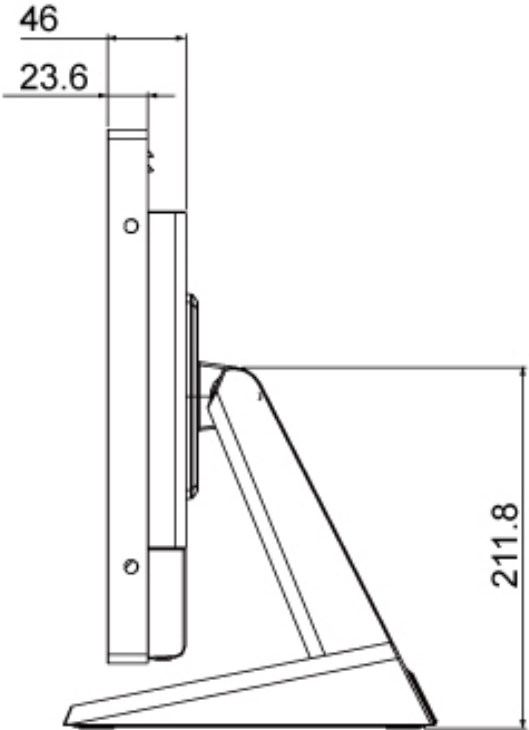

# Rear View

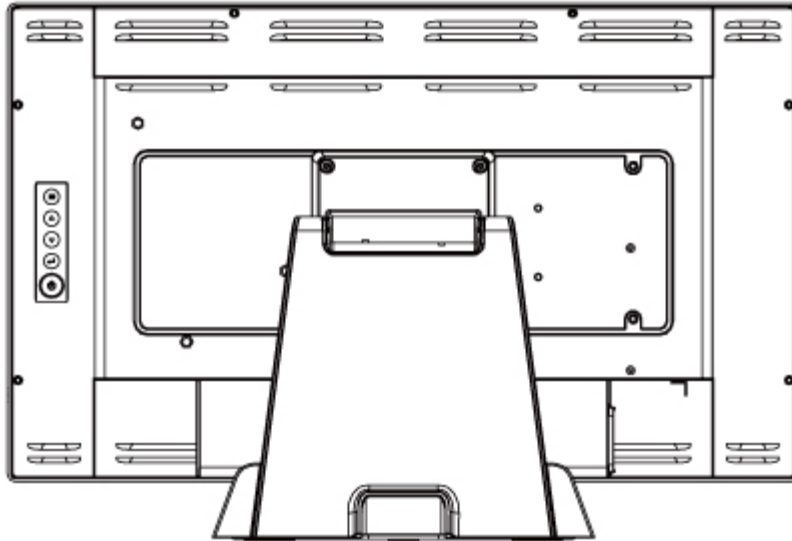
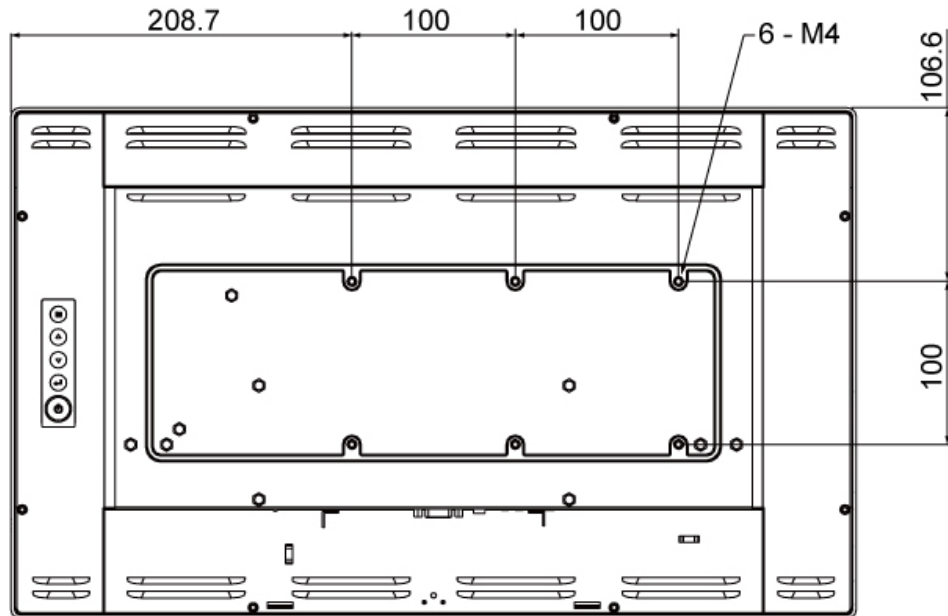

# Appendix

## Cleaning

Turn off the product and disconnect from AC power before cleaning. Turning the product off protects against accidental touch selections that could cause problems or hazardous results. Disconnecting power protects against hazardous interaction between accidental liquid entry and electricity.

To clean the case, dampen a clean cloth lightly with water and a mild detergent and wipe gently. Use a soft, dry cloth to clean areas that have ventilation openings to avoid getting any liquid or moisture inside. If liquid does get inside, do not use the product until it has been inspected and tested by a qualified service technician.

To clean the touch screen, apply a glass cleaning solution to a soft cloth and wipe the screen clean. To ensure that liquid does not enter the product, do not spray cleaning solution directly onto the touch screen or any other part.

Do not use volatile solvents, waxes or any abrasive cleaners on any part of the product.

## Solutions to Common Problems

### No image on monitor

Check that the video signal source device is turned on.

Check that the selected video input signal matches the video connection.

The monitor or computer may be in SLEEP mode. Press any key/move the mouse/touch the touchscreen and wait a few seconds to see if the image appears.

Check that the DC power connector is fully seated.

Check that the AC cable is securely connected to the wall outlet and to the AC to DC converter.

Make sure the MicroTouch power converter is being used.

Try another MicroTouch-approved power converter if possible.

### Monitor display is dim.

Use the OSD controls to increase the brightness.

Use the OSD controls to increase the contrast.

### Monitor displays the “Out of Range” message.

This message will only occur when using the VGA video signal input; use either the HDMI or Display Port video signal input if your signal source equipment supports either of those.

Reduce the resolution to a resolution the monitor supports – see the Supported Timings chart in the Specifications and Dimensions section of this manual.

### Monitor display image looks strange.

Try the Auto Adjust function in the OSD (only available when using the VGA video signal input).

Adjust your computer’s resolution/timing mode to be within the allowable timing ranges specified for your touch monitor (see section above).

### Touch functionality doesn’t work or works incorrectly.

Make sure the USB cable is properly connected.

Fully remove any protective sheets from the screen, then cycle power Off/On.

Ensure that the monitor is in an upright position with nothing touching the screen, then cycle power Off/On.

Legacy operating systems, prior to circa 2007, may require drivers to support Touch Devices. Please contact MicroTouch Technical Support.

### Neither the OSD nor power buttons respond when pressed.

If the wired OSD remote is in use, make sure it is securely connected.

## Warranty Information

Except as otherwise stated herein, or in an order acknowledgment delivered to Buyer, Seller warrants to Buyer that the Product shall be free of defects in materials and workmanship. The warranty for the touchscreen display and their components is three years. Seller makes no warranty regarding the model life of components. Seller's suppliers may at any time and from time to time make changes in the components delivered as Products or components. Buyer shall notify Seller in writing promptly (and in no case later than 30 days after discovery) of the failure of any Product to conform to the warranty set forth above; shall describe in commercially reasonable detail in such notice the symptoms associated with such failure; and shall provide to Seller the opportunity to inspect such Products as installed, if possible. The notice must be received by Seller during the Warranty Period for such product, unless otherwise directed in writing by the Seller. Within thirty days after submitting such notice, Buyer shall package the allegedly defective Product in its original shipping carton(s) or a functional equivalent and shall ship to Seller at Buyer's expense and risk. Within a reasonable time after receipt of the allegedly defective Product and verification by Seller that the Product fails to meet the warranty set forth above, Seller shall correct such failure by, at Seller's options, either (i) modifying or repairing the Product or (ii) replacing the Product. Such modification, repair, or replacement and the return shipment of the Product with minimum insurance to Buyer shall be at Seller's expense. Buyer shall bear the risk of loss or damage in transit, and may insure the Product. Buyer shall reimburse Seller for transportation cost incurred for Product returned but not found by Seller to be defective. Modification or repair, of Products may, at Seller's option, take place either at Seller's facilities or at Buyer's premises. If Seller is unable to modify, repair, or replace a Product to conform to the warranty set forth above, then Seller shall, at Seller's option, either refund to Buyer or credit to Buyer's account the purchase price of the Product less depreciation calculated on a straight-line basis over Seller's stated Warranty Period. These remedies shall be the buyer's exclusive remedies for breach of warranty. Except for the express warranty set forth above, seller grants no other warranties, express or implied by statute or otherwise, regarding the products, their fitness for any purpose, their quality, their merchantability, their non-infringement, or otherwise. No employee of Seller or any other party is authorized to make any warranty for the goods other than the warranty set forth herein. Seller's liability under the warranty shall be limited to a refund of the purchase price of the product. In no event shall Seller be liable for the cost of procurement or installation of substitute goods by Buyer or for any special, consequential, indirect, or incidental damages. Buyer assumes the risk and agrees to indemnify Seller against and hold Seller harmless from all liability relating to (i) assessing the suitability for Buyer's intended use of the Products and of any system design or drawing and (ii) determining the compliance of Buyer's use of the Products with applicable laws, regulations, codes, and standards. Buyer retains and accepts full responsibility for all warranty and other claims relating to or arising from Buyer's products, which include or incorporate Products or components manufactured or supplied by Seller. Buyer is solely responsible for any and all representations and warranties regarding the Products made or authorized by Buyer. Buyer will indemnify Seller and hold Seller harmless from any liability, claims, loss, cost, or expenses (including reasonable attorney's fees) attributable to Buyer's products or representations or warranties concerning same.

## RoHS Declaration

Equipment name : Touch LCD Monitor    Type designation (Type) : DT-215P-M1						
Component	Restricted substances and their chemical symbols					
	Lead (Pb)	Mercury (Hg)	Cadmium (Cd)	Hexavalent chromium (Cr <sup>+6</sup> )	Polybrominated biphenyls (PBB)	Polybrominated diphenyl ethers (PBDE)
Plastic Parts	○	○	○	○	○	○
Metal Parts	-	○	○	○	○	○
Cable components	-	○	○	○	○	○
LCD Panel	-	○	○	○	○	○
Touch Panel	-	○	○	○	○	○
PCBA	-	○	○	○	○	○
Software	○	○	○	○	○	○
Notes						
<p>“○” indicates that the percentage of the restricted substance does not exceed the permissible limit.</p> <p>“-” indicates that the restricted substance is exempt.</p>						





[www.MicroTouch.com](http://www.MicroTouch.com) | [www.usorders@microtouch.com](mailto:www.usorders@microtouch.com)  
TES AMERICA LLC | 215 Central Avenue, Holland, MI 49423 | (616) 786-5353

The information presented in this user manual is intended as general information about MicroTouch products and is subject to change. Product specifications and warranties will be governed by TES America, LLC. Standard terms and conditions of sale. Products are subject to availability. Copyright © 2022 TES America, LLC. All rights reserved. Android is a trademark of Google LLC. Windows is a trademark of Microsoft Corporation in the United States and other countries.

