

# User Manual

## OF-320P-A1

Open Frame Touch Monitor



## About This Document

No part of this publication may be reproduced, transmitted, transcribed, stored in a retrieval system, or translated into any language or computer language, in any form or by any means, including, but not limited to, electronic, magnetic, optical, chemical, manual, or otherwise without prior written permission of MicroTouch™ a TES Company.

The information in this document is subject to change without notice. MicroTouch™ a TES Company makes no representations or warranties with respect to the contents herein, and specifically disclaims any implied warranties of merchantability or fitness for a particular purpose. MicroTouch™ a TES Company reserves the right to revise this publication and to make changes from time to time in the content hereof without obligation of MicroTouch™ a TES Company to notify any person of such revisions or changes. Windows is a registered trademark of Microsoft, Inc. Other brand or product names are trademarks of their respective holders.

## **Compliance Information**

### **For FCC (USA)**

This equipment has been tested and found to comply with the limits for a Class B digital device, pursuant to part 15 of the FCC Rules. These limits are designed to provide reasonable protection against harmful interference in a residential installation. This equipment generates, uses, and can radiate radio frequency energy, and if not installed and used in accordance with the instructions, may cause harmful interference to radio communications. However, there is no guarantee that interference will not occur in a particular installation. If this equipment does cause harmful interference to radio or television reception, which can be determined by turning the equipment off and on, the user is encouraged to try to correct the interference by one or more of the following measures:

- Reorient or relocate the receiving antenna.
- Increase the separation between the equipment and receiver.
- Connect the equipment into an outlet on a circuit different from that to which the receiver is connected.
- Consult the dealer or an experienced radio/TV technician for help.

This device complies with part 15 of the FCC Rules. Operation is subject to the following two conditions: (1) this device may not cause harmful interference, and (2) this device must accept any interference received, including interference that may cause undesired operation.

### **For IC (Canada)**

CAN ICES-3(B)/NMB-3(B)

### **For CE (EU)**

The device complies with the EMC Directive 2014/30/EU and Low Voltage Directive 2014/35/EU

## Renseignements relatifs à la conformité

### **Pour la FCC (États-Unis).**

Ce matériel a fait l'objet d'essais qui ont déterminé qu'il respectait les limites d'un appareil de classe B selon la partie 15 des règlements de la FCC. Ces limites sont établies pour assurer une protection raisonnable contre les parasites nuisant à une installation résidentielle. Ce matériel génère, utilise et peut émettre des ondes radio électriques, et lorsqu'il n'est pas installé et utilisé selon les instructions, peut causer des parasites nuisant aux communications radio. Il n'y a toutefois aucune garantie qu'il n'y aura pas de parasites dans une installation en particulier. Si ce matériel cause des parasites à la réception d'ondes radio ou de télévision, ce qui peut être déterminé en l'éteignant et en l'allumant, l'utilisateur est invité à essayer de corriger le problème des parasites par l'une ou l'autre des mesures suivantes :

- Réorienter ou déplacer l'antenne de réception.
- Augmenter la distance entre le matériel et la réception.
- Brancher le matériel dans une prise sur un autre circuit que celui où le récepteur est branché.
- Consulter le distributeur ou un technicien radio ou TV expérimenté pour des conseils.

L'appareil respecte la partie 15 des règlements de la FCC. Le fonctionnement doit respecter les deux conditions suivantes : 1) cet appareil ne doit pas causer de parasites et (2) cet appareil doit accepter tous les parasites reçus, notamment ceux pouvant causer un fonctionnement non voulu.





### **Pour Industrie Canada**

Norme canadienne NMB-3(B)

### **Pour la CE (UE)**

L'appareil respecte la directive 2014/30/UE relative à la compatibilité électromagnétique et la directive 2014/35/EU sur les limites de basse tension

## Usage Notice

-  **Warning - To prevent the risk of fire or shock hazards, and do not expose the product to moisture.**
-  **Warning - Please do not open or disassemble the product as this may cause electric shock.**
-  **Warning - Power cord shall be connected to a socket-outlet with earthing connection.**
-  **Warning - The cable cover cannot be removed under normal use conditions.**
-  **Warning - Stability Hazard. The touch monitor may fall, causing serious personal injury or death. To prevent injury, this touch monitor must be securely attached to the wall in accordance with the installation instructions.**

## Precautions

Please follow all warnings, precautions and maintenance as recommended in this user's manual to maximize the life of your unit.

### **Do :**

- Turn off the product before cleaning.
- Use a soft cloth moistened with mild detergent to clean the product housing.
- Use only the qualified power adapter that comes with your device.
- Disconnect the power plug from AC outlet if the product is not going to be used for an extended period of time.

### **Don't :**

- Do not use abrasive cleaners, waxes or solvents for your cleaning.
- Do not operate the product under the following conditions:
  - Extremely hot, cold or humid environment.
  - Areas susceptible to excessive dust and dirt.
  - Near any appliance generating a strong magnetic field.

## Avis d'utilisation



Mise en garde — Pour prévenir les risques d'incendie ou d'électrocution, ne pas exposer le produit à l'humidité.



Mise en garde — Prière de ne pas ouvrir ou démonter le produit, car cela pourrait entraîner l'électrocution.



Mise en garde – Le cordon d'alimentation doit être branché à une prise pourvue d'une mise à la terre.



Mise en garde – La gaine du câble ne doit pas être retirée en conditions normales d'utilisation.



Mise en garde — Risque de renversement. Le moniteur tactile peut se renverser et causer de graves blessures corporelles, voire la mort. Pour prévenir les blessures, ce moniteur tactile doit être solidement fixé au mur selon les instructions d'installation.

## Précautions

Veillez suivre toutes les mises en garde, précautions et entretiens recommandés dans ce manuel d'utilisation pour maximiser la durée de vie de votre unité.

### À faire :

- Éteindre l'appareil avant de le nettoyer.
- Utiliser un chiffon humidifié par une solution savonneuse pour nettoyer le boîtier du produit.
- Utiliser uniquement l'adaptateur d'alimentation prescrit pour votre appareil.
- Débrancher l'appareil lorsqu'il n'est pas utilisé pendant une période prolongée.

### À éviter :

- Ne pas utiliser de nettoyeurs abrasifs, de cires ou de solvants pour le nettoyage
- Ne jamais utiliser l'appareil dans les conditions suivantes :
  - des conditions environnementales extrêmes (chaud, froid ou humidité)
  - des endroits remplis de poussières et de saletés.
  - à proximité d'appareils produisant un fort champ magnétique.

# Table of Contents

<b>Chapter 1</b> .....	<b>7</b>
1.1 Overview.....	8
1.2 Feature .....	8
1.3 Specifications.....	8
1.4 Block Diagram.....	9
1.5 Interface Connectors.....	10
1.5.1 Power Connector .....	<b>10</b>
1.5.2 Video Signal Connector .....	10
1.5.3 Signal Connector.....	12
1.6 Package Overview .....	13
<b>Chapter 2</b> .....	<b>15</b>
2.1 About VESA Mount .....	16
2.1.1 Install the VESA screw .....	17
2.2 About General Mounting Information .....	18
2.2.1 Landscape .....	18
2.2.2 Portrait .....	18
2.3 On-Screen Display.....	19
2.3.1 OSD Function Description.....	21
2.3.2 Timing Table Chart.....	22
2.3.3 EDID Data .....	<b>22</b>
2.4 Dimension.....	23
2.4.1 Front View .....	23
2.4.2 Side View .....	23
2.4.3 Rear View .....	23
<b>Appendix</b> .....	<b>25</b>

# Chapter 1

---

Product Introduction



## 1.1 Overview

OF-320P-A1 series supports landscape or portrait and low power consumption at the maximum consumption of 45W. OF-320P-A1 provides application for Interactive whiteboard and digital signage.

## 1.2 Feature

- VESA mounting holes for various mounting options.
- Multilingual OSD user control
- High Resolution FHD (1920 x 1080)

## 1.3 Specifications

LCD Touch Panel	
Size	31.5" TFT LCD
Brightness	>250 cd/m <sup>2</sup> (Non-touch screen) >225 cd/m <sup>2</sup> (Non-AG PCAP) > 210cd/m <sup>2</sup> (AG PCAP)
Number of Pixels	1920(H) x 1080(V)
Touch Type	P-CAP/ 30 points
Environment	
Power Input	100-240V ~ 1.5A 50/60Hz
Operating Temperature	0°C ~ 40°C
Storage Temperature	-20°C ~ 60°C
Operating Humidity	20% ~ 80% RH, non-condensing
Mounting	VESA 200 mm x 200 mm
Dimension (W x H x D)	433.85mm x 61mm x 739.4 mm
Net Weight	10.35 kg
Gross Weight	12.85 kg

## 1.4 Block Diagram

This section describes the electrical requirements of the monitor. The block diagram in figure 1 illustrates the various electrical sub-systems.

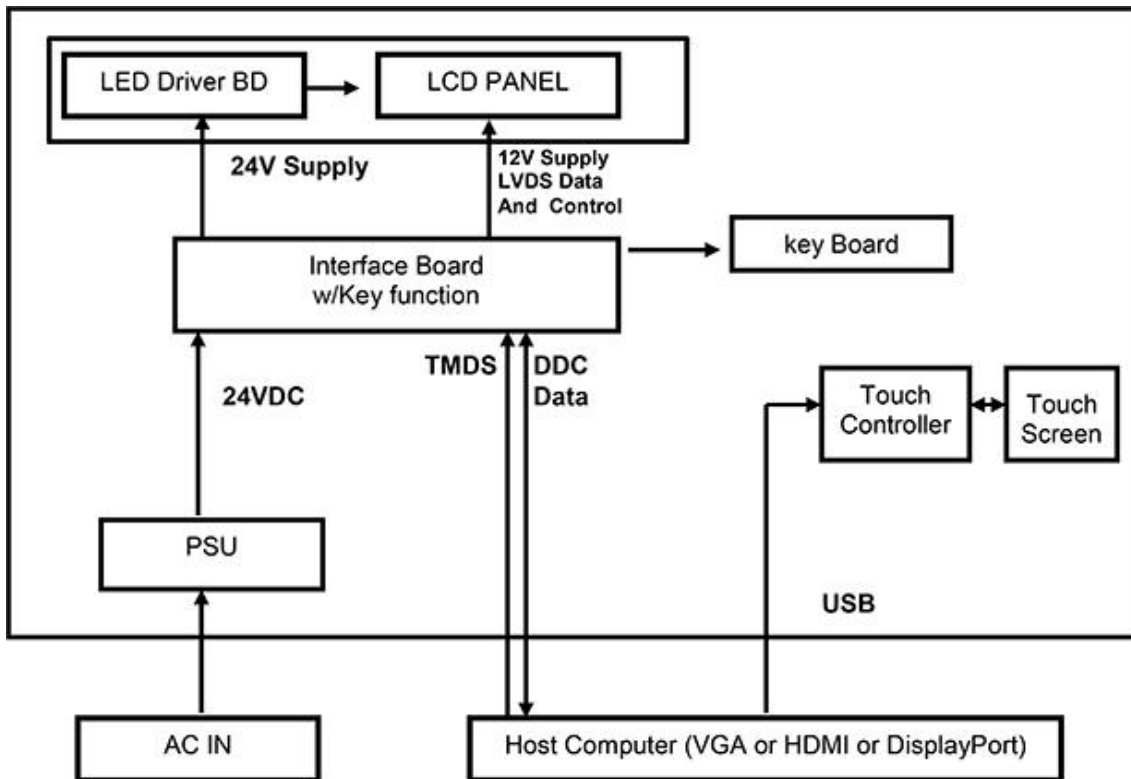

## 1.5 Interface Connectors

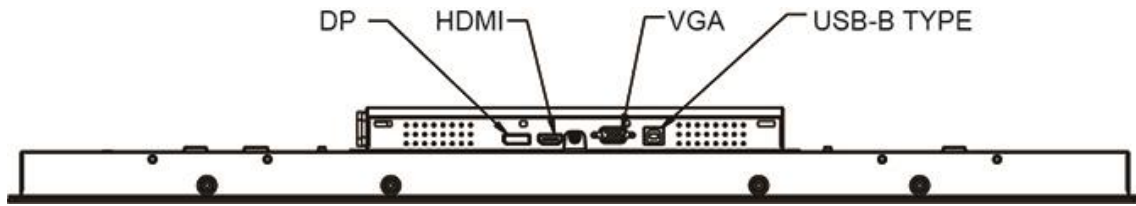

### 1.5.1 Power Connector

The monitor shall have a power control switch visible and accessible on the bottom of the monitor. The power switch shall be marked with icons per IEC 417, #5009. The operation of the power switch should be programmable thru monitor firmware control.

### 1.5.2 Video Signal Connector

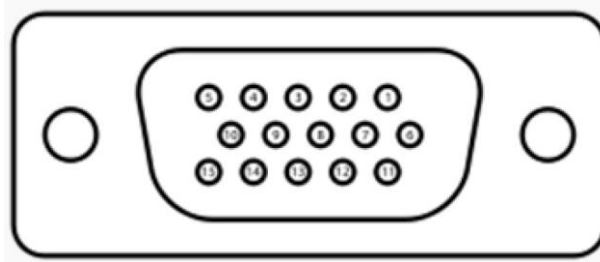

VGA

Pin	Name	Description
1	Red	Analog signal input
2	Green	Analog signal input
3	Blue	Analog signal input
4	Reserved	NC
5	GND	Ground
6	Red Return	Ground
7	Green Return	Ground
8	Blue Return	Ground
9	5V	Supply
10	GND	Ground
11	Reserved	NC
12	DDC DATA	VGA DDC DATA
13	HS	Horizontal Sync
14	VS	Vertical Sync
15	DDC CLK	VGA DDC CLK

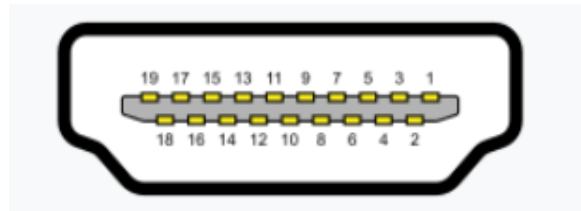

### HDMI

Pin	Name	Description
1	DATA2+	TMDS Data+
2	Dat2 shield	TMDS Data Shield
3	DATA2-	TMDS Data-
4	DATA1	TMDS Data+
5	Dat1 shield	TMDS Data Shield
6	DATA2-	TMDS Data-
7	DATA0	TMDS Data+
8	Dat0 shield	TMDS Data Shield
9	DATA0-	TMDS Data-
10	clk+	TMDS Clock+
11	clk shield	TMDS Clock Shield
12	clk-	TMDS Clock-
13	CEC	CEC
14	Reserved	Reserved (NC. on device )
15	DDC SCL	SCL(I <sup>2</sup> C serial clock for DDC)
16	DDC SDA	SCL(I <sup>2</sup> C serial data for DDC)
17	CEC/DDC GND	DDC/CEC Ground
18	5V	+5 V Power
19	HPD	Hot Plug Detect

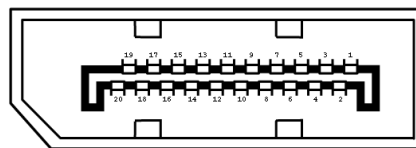

### DisplayPort

Pin	Signal	Pin	Signal
1	ML_Lane 0(p) Data0 +	11	Signal ground
2	Signal ground	12	ML_Lane 3(n) Data3 -
3	ML_Lane 0(n) Data0 -	13	Signal ground
4	ML_Lane 1(p) Data1 +	14	Signal ground
5	Signal ground	15	AUX_CH(p) AUX + Signal for Auxiliary Channel

6	ML_Lane 1(n) Data1 -	16	Signal ground
7	ML_Lane 2(p) Data2 +	17	AUX_CH(n) AUX - Signal for Auxiliary Channel
8	Signal ground	18	Hot Plug
9	ML_Lane 2(n) Data 2 -	19	DP_PWR Return
10	ML_Lane 3(p) Data3 +	20	DP_PWR



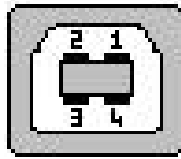

### 1.5.3 Signal Connector

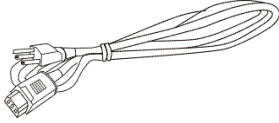
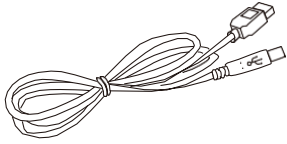

**USB Connector**

Pin	Name	Description
1	VCC	USB Power -5V
2	D-	Data -
3	D+	Data +
4	GND	Ground

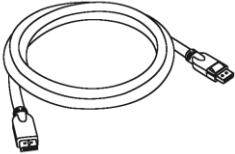
## 1.6 Package Overview

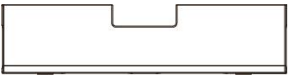
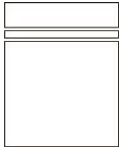
		
LCD	Power Cord	USB cable (A to B)
		
HDMI cable	DP(Option)	Cable tie
		
M3 screw	Cable cover	Zip bag

### Warning!

*This product is intended to be supplied by a AC-in Power source, rated 100V~240V, 1.5A 50/60Hz minimum, T<sub>ma</sub> = 40 degree C minimum, and the altitude of operation = 3048m minimum. If it needs further assistance with purchasing the power source, please contact to MicroTouch for further information*



**Mise en garde!**

*Cet appareil est conçu avec une alimentation de courant CA, d'une tension nominale de 100 V~240 V, 1,5 A 50/60 Hz minimum, T<sub>ma</sub> = 40 degrés C minimum et l'altitude de l'utilisation = 3048 m minimum. Pour d'autres conseils pour l'installation de la source d'alimentation, communiquer avec MicroTouch pour de plus amples renseignements.*

# Chapter 2

---

## Product Installation



## 2.1 About VESA Mount

The OF-320P-A1 series conform to the “VESA Flat Display Mounting Interface Standard” which defines a physical mounting interface for touch monitor and corresponding with the standards of touch monitor mounting devices. The VESA mount is located on the back of this unit.

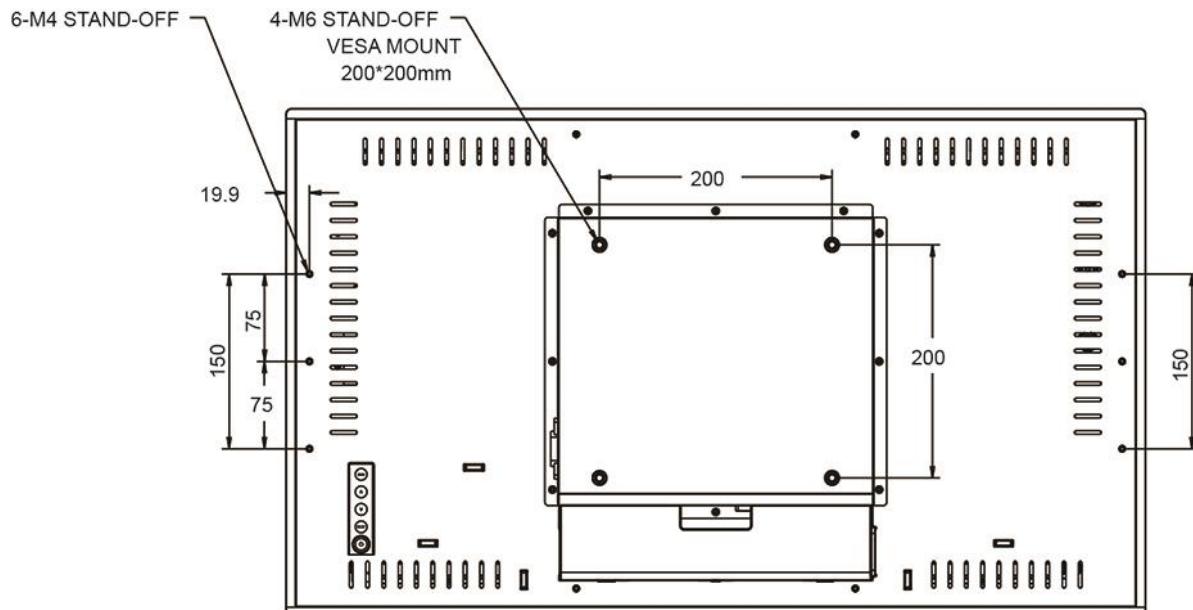

### Warning!

*Please select the MicroTouch original screws!  
The distance between the back cover surface and the bottom of the screw hole is 6~7 mm. Please use M6 8mm screws diameter with to mount your monitor.*

*Note: The mounting stand must be able to support at least 33 lbs (15.0 Kg).*

### Mise en garde!

*Sélectionner les vis d'origine de MicroTouch!  
La distance entre la surface du couvercle arrière et le bas de l'orifice de la vis est de 6 à 7 mm. Utiliser les vis M6 de 8 mm de diamètre pour le montage de votre moniteur.*

*Remarque : Le support de montage doit pouvoir supporter un poids d'au moins 33 lb (15,0 kg).*

### 2.1.1 Install the VESA screw

Note: Please install/ dismantle the product when the device is in the shutdown state.  
Please use M6/8mm screws diameter with to mount your monitor.

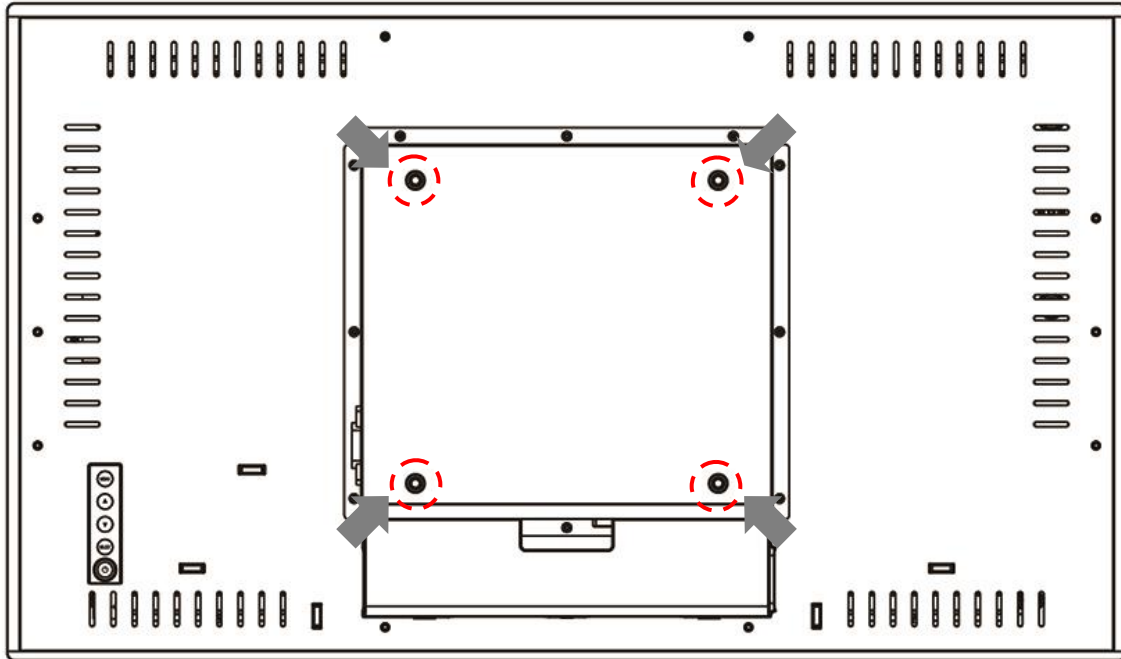

## 2.2 About General Mounting Information

The following two mounting orientations are supported: Landscape and portrait mode. For optimal touch performance, ensure that the monitor is supported fully and is as flat as possible.

### 2.2.1 Landscape

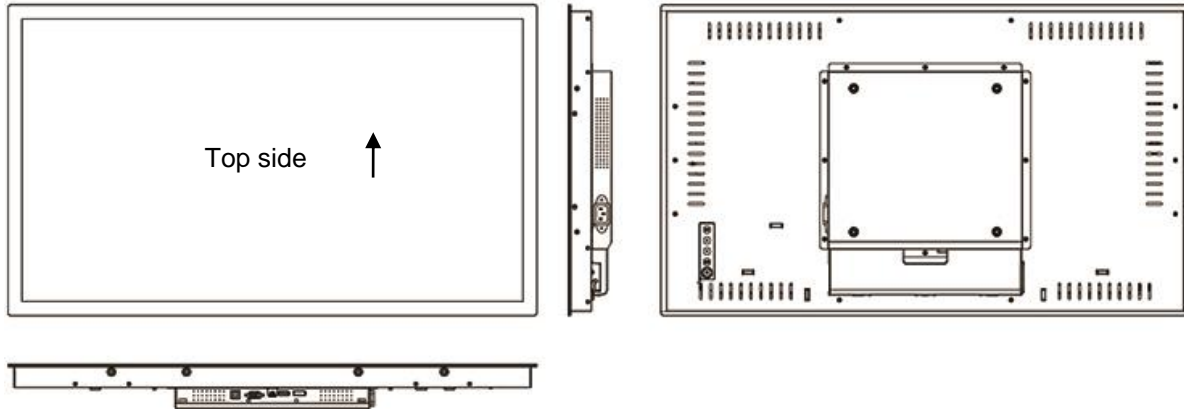

### 2.2.2 Portrait

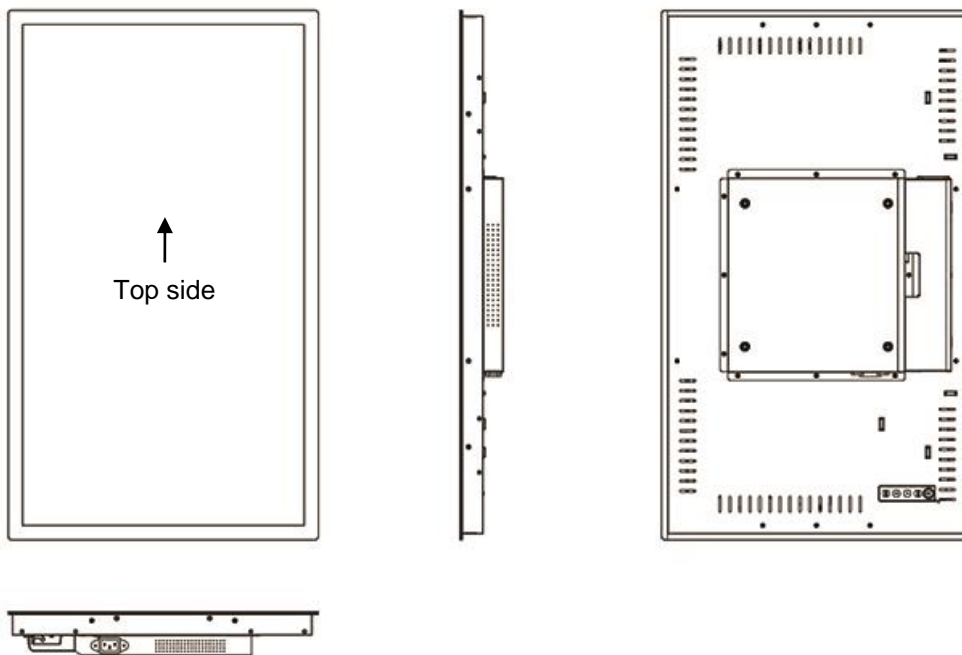

## 2.3 On-Screen Display

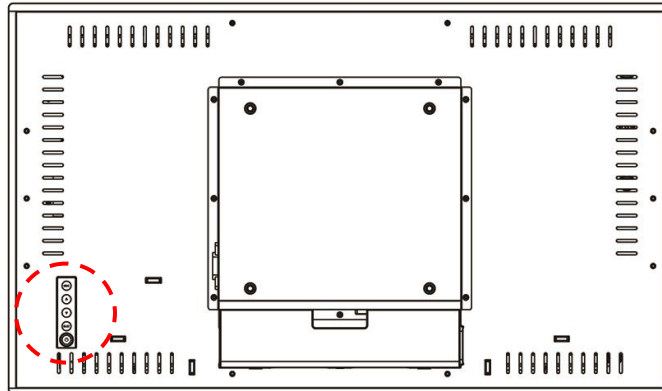

The OF-320P-A1 series provide side panel controls. And the following is OSD function table:

Key \ OSD	Menu off status	Menu on status
<b>MENU</b>	Menu appear	Menu disappear/ return to main item
▲	Brightness	Main item select up/ Adjust up
▼	Contrast	Main item select down/ Adjust down
<b>SELECT</b>	Source Select	Enter/Select sub-item function
⏻	Power On/Off	

1. Press the “MENU” button to pop up the “on-screen menu” and press “Up” or “Down” button to select among the four functions in the main menu.
2. Choose the adjustment items by pressing the “SELECT ” button.
3. Adjust the value of the adjustment items by pressing the “Up” or “Down” button.
4. With the OSD menu on screen, press “ Menu” button to return main menu or exit OSD.
5. The OSD menu will automatically close, if you have left it idle for a pre-set time.
6. To Lock / Unlock the OSD / Power menu buttons, press “Menu” and “Minus” at the same time to select OSD / Power the Lock / Unlock function.

**Please note:**

- a. When the OSD Lock function is selected, this indicates that all the buttons except “power” button are now disabled.
  - b. When the Power Lock function is selected, this indicates that the power key is disabled; user can not to turn off the monitor by "Power" key.
7. To disable the touch function, press “Menu” and “Enter” Key, at the same time.
  8. To enable the touch function, press “Menu” and “Enter” Key, at the same time for five seconds.
  9. Press the power key button, there will be an OSD window pop up to ask if it should be going off.  
If press the power key in five seconds, the monitor power will be off. If don't press the power key in five seconds, the OSD window will be gone and return to the normal status instead.

10. Direct input select function

Normal:

Press and keep pressing "Select" key for 3 seconds, will change to pop up "source select" OSD.

Sleep status:

Press and keep pressing "Select" key for 1 seconds, will change to pop up "source select" OSD.

**Please note:**

When choosing VGA, only VGA signal can wake up monitor. When choosing HDMI, only HDMI can wake up the monitor. When choosing DisplayPort, only DisplayPort can wake up the monitor.

11. Factory mode:

Press the "MENU" button to pop up the "on-screen menu" and select "Option" icon in "Factory" item, key in password "3","3","3","3" into factory mode.

12. Burn-in mode:

In Factory mode to select "Burn In" item into Burin-in mode (unplug signal cable or do not enter the signal source).

13. Work time:

In factory mode, displays monitor the work time counting in hours.

### 2.3.1 OSD Function Description

Item	Content	Default
Contrast	The monitor luminance level control.	50
Brightness	The monitor backlight level control.	65
H-Positon	Moving screen image horizontal position to left or right.	NA
V-Positon	Moving screen image vertical position to up or down.	NA
Phase	The screen image horizontal dot clock adjustment.	NA
Clock	The screen image pixel phase adjustment.	NA
Auto Adjust	Fine-tune the image to full screen automatically.	NA
Color Temp	Color temperature selection. (9300K, 6500K, 5500K, 7500K, User)	USER
Sharpness	Adjust the screen sharpness.	50
OSD Timeout	OSD auto-disappear time selection.	15
OSD Positon	Moving OSD menu position.	User
OSD H-Positon	Moving OSD menu horizontal position to left or right.	50
OSD V-Positon	Moving OSD menu vertical position to up or down.	50
Touch Switch	Touch switch select.(Normal, Glove, Through-Glass)	Normal
Reset	Factory default value restored.	NA
OSD Language	OSD menu language selection. (English, French, Deutsch, Italian, Spanish, Japanese, Traditional Chinese and Simplified Chinese)	English
Source Select	Select Input function. (Auto, VGA,HDMI, DisplayPort)	Auto
Display port	Display current resolution related information.	NA
Factory	Factory mode related adjustment items.	NA

### 2.3.2 Timing Table Chart

Mode	Resolution	H-Freq. (KHz)	Band Width (MHz)	Polarity	
				H	V
1	640x480 60Hz	31.47	25.175	-	-
2	800x600 60Hz	37.88	40	+	+
3	1024x768 60Hz	48.36	65	-	-
4	1280x720 60Hz	44.77	74.5	-	+
5	1280x1024 60Hz	64	108	+	+
6	1366x768 60Hz	47.7	85.38	+	+
7	1680x1050 60Hz	65.2	146	-	+
8	1920X1080 60Hz	67.5	148.5	+	+

### 2.3.3 EDID Data

#### VGA

The monitor assembly shall provide a display communications channel that conforms to VESA DDC2B hardware requirements. This configuration shall contain the 128-byte EDID file as specified by VESA EDID Standard.

#### HDMI, DisplayPort

The monitor assembly shall provide a display communications channel that conforms to VESA DDC2B hardware requirements. This configuration shall contain the 256-byte EDID file as specified by VESA EDID Standard.

## 2.4 Dimension

### 2.4.1 Front View

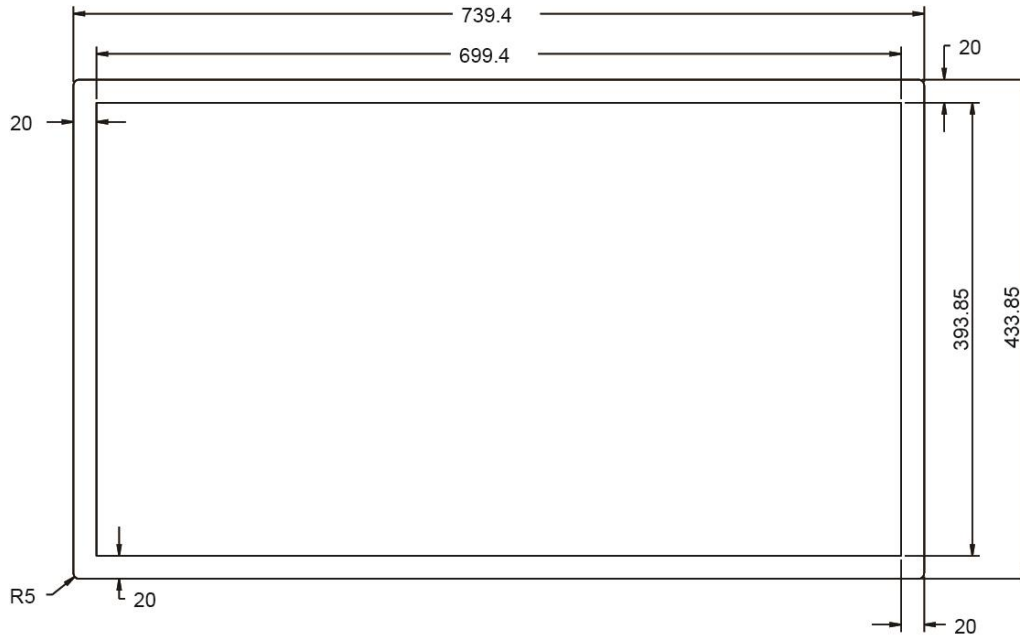

### 2.4.2 Side View

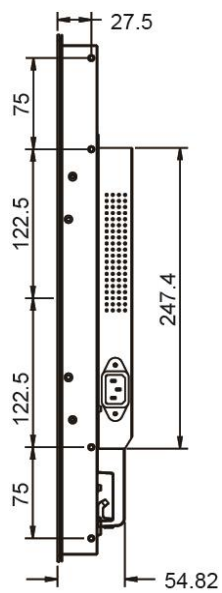



### 2.4.3 Rear View

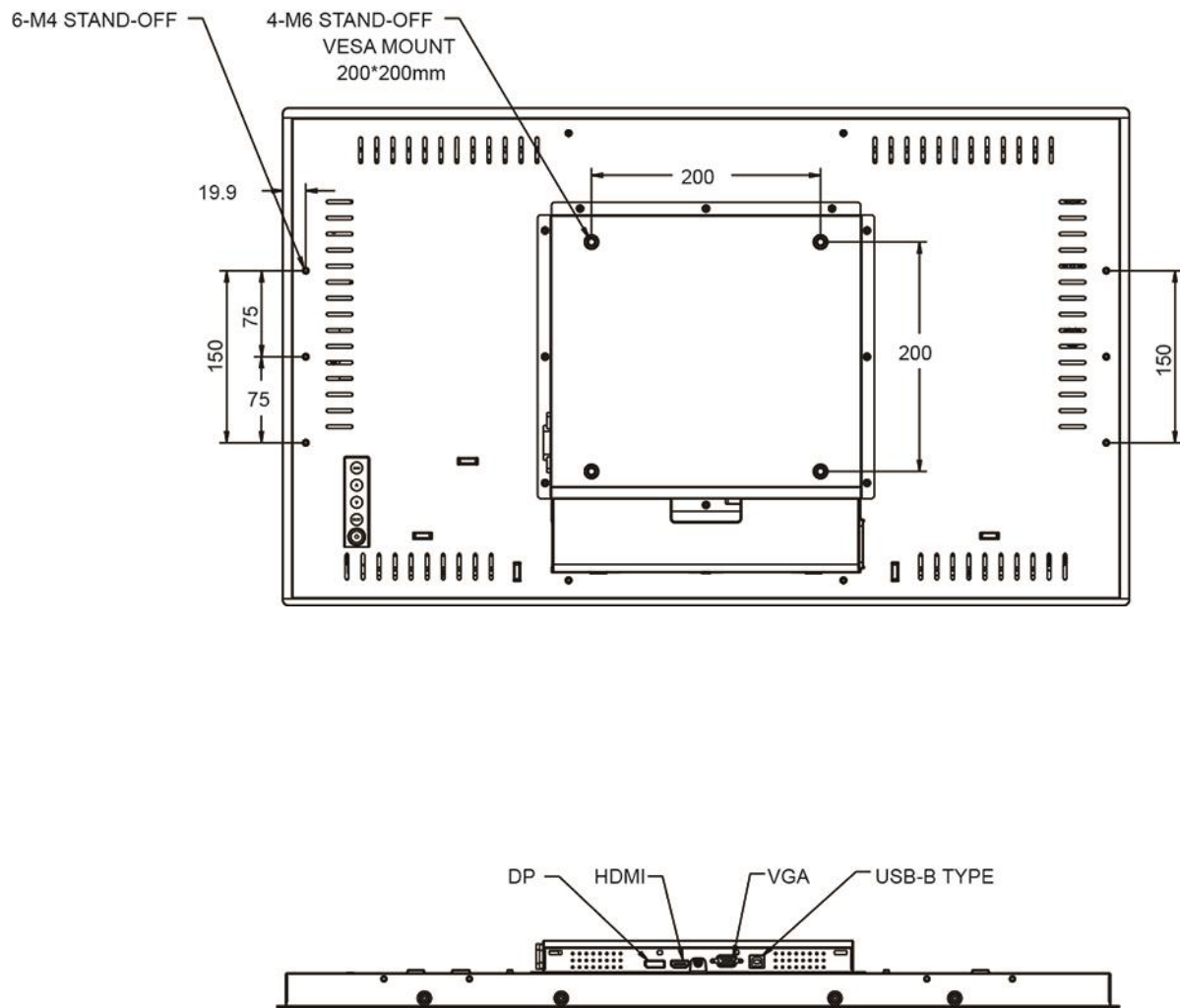

# Appendix

---

## Declaration of the Presence Condition of the Restricted Substances Marking

設備名稱：觸控螢幕 Equipment name : Touch Monitor		型號 (型式) : OF-320P-A1 Type designation (Type) : OF-320P-A1				
單元 Unit	限用物質及其化學符號 Restricted substances and its chemical symbols					
	鉛 Lead (Pb)	汞 Mercury (Hg)	鎘 Cadmium (Cd)	六價鉻 Hexavalent chromium (Cr <sup>+6</sup> )	多溴聯苯 Polybrominated biphenyls (PBB)	多溴二苯醚 Polybrominated diphenyl ethers (PBDE)
塑膠零件 Plastic Parts	○	○	○	○	○	○
金屬零件 Metal Parts	-	○	○	○	○	○
線纜和電纜組件 Cable component	-	○	○	○	○	○
薄膜液晶面板 LCD Panel	-	○	○	○	○	○
觸控式螢幕面板 Touch Panel	-	○	○	○	○	○
電路板 PCBA	-	○	○	○	○	○
軟體(光碟..等) Software	○	○	○	○	○	○
<p>Note 1 : "Exceeding 0.1 wt %" and "exceeding 0.01 wt %" indicate that the percentage content of the restricted substance exceeds the reference percentage value of presence condition. °</p> <p>Note 2 : "○" indicates that the percentage content of the restricted substance does not exceed the percentage of reference value of presence.</p> <p>Note 3 : The "-" indicates that the restricted substance corresponds to the exemption.</p>						