

User Manual

Version 6.0 2020/01

OF-150P-B1

Touch LCD Monitor



About This Document

No part of this publication may be reproduced, transmitted, transcribed, stored in a retrieval system, or translated into any language or computer language, in any form or by any means, including, but not limited to, electronic, magnetic, optical, chemical, manual, or otherwise without prior written permission of MicroTouch™ a TES Company.

The information in this document is subject to change without notice. MicroTouch™ a TES Company makes no representations or warranties with respect to the contents herein, and specifically disclaims any implied warranties of merchantability or fitness for a particular purpose. MicroTouch™ a TES Company reserves the right to revise this publication and to make changes from time to time in the content hereof without obligation of MicroTouch™ a TES Company to notify any person of such revisions or changes. Windows is a registered trademark of Microsoft, Inc. Other brand or product names are trademarks of their respective holders.

Compliance Information

For FCC (USA)

This equipment has been tested and found to comply with the limits for a Class B digital device, pursuant to part 15 of the FCC Rules. These limits are designed to provide reasonable protection against harmful interference in a residential installation. This equipment generates, uses, and can radiate radio frequency energy, and if not installed and used in accordance with the instructions, may cause harmful interference to radio communications. However, there is no guarantee that interference will not occur in a particular installation. If this equipment does cause harmful interference to radio or television reception, which can be determined by turning the equipment off and on, the user is encouraged to try to correct the interference by one or more of the following measures:

- Reorient or relocate the receiving antenna.
- Increase the separation between the equipment and receiver.
- Connect the equipment into an outlet on a circuit different from that to which the receiver is connected.
- Consult the dealer or an experienced radio/TV technician for help.

This device complies with part 15 of the FCC Rules. Operation is subject to the following two conditions: (1) this device may not cause harmful interference, and (2) this device must accept any interference received, including interference that may cause undesired operation.

For IC (Canada)

CAN ICES-3(B)/NMB-3(B)

For CE (EU)

The device complies with the EMC Directive 2014/30/EU and Low Voltage Directive 2014/35/EU

Renseignements relatifs à la conformité

Pour la FCC (États-Unis).

Ce matériel a fait l'objet d'essais qui ont déterminé qu'il respectait les limites d'un appareil de classe B selon la partie 15 des règlements de la FCC. Ces limites sont établies pour assurer une protection raisonnable contre les parasites nuisant à une installation résidentielle. Ce matériel génère, utilise et peut émettre des ondes radio électriques, et lorsqu'il n'est pas installé et utilisé selon les instructions, peut causer des parasites nuisant aux communications radio. Il n'y a toutefois aucune garantie qu'il n'y aura pas de parasites dans une installation en particulier. Si ce matériel cause des parasites à la réception d'ondes radio ou de télévision, ce qui peut être déterminé en l'éteignant et en l'allumant, l'utilisateur est invité à essayer de corriger le problème des parasites par l'une ou l'autre des mesures suivantes :

- Réorienter ou déplacer l'antenne de réception.
- Augmenter la distance entre le matériel et la réception.
- Brancher le matériel dans une prise sur un autre circuit que celui où le récepteur est branché.
- Consulter le distributeur ou un technicien radio ou TV expérimenté pour des conseils.

L'appareil respecte la partie 15 des règlements de la FCC. Le fonctionnement doit respecter les deux conditions suivantes : 1) cet appareil ne doit pas causer de parasites et (2) cet appareil doit accepter tous les parasites reçus, notamment ceux pouvant causer un fonctionnement non voulu.





Pour Industrie Canada

Norme canadienne NMB-3(B)

Pour la CE (UE)

L'appareil respecte la directive 2014/30/UE relative à la compatibilité électromagnétique et la directive 2014/35/EU sur les limites de basse tension

Usage Notice

-  **Warning - To prevent the risk of fire or shock hazards, and do not expose the product to moisture.**
-  **Warning - Please do not open or disassemble the product as this may cause electric shock.**
-  **Warning - Power cord shall be connected to a socket-outlet with earthing connection.**
-  **Warning - The cable cover cannot be removed under normal use conditions.**
-  **Warning - Stability Hazard. The touch monitor may fall, causing serious personal injury or death. To prevent injury, this touch monitor must be securely attached to the wall in accordance with the installation instructions.**

Precautions

Please follow all warnings, precautions and maintenance as recommended in this user's manual to maximize the life of your unit.

Do :

- Turn off the product before cleaning.
- Use a soft cloth moistened with mild detergent to clean the product housing.
- Use only the qualified power adapter that comes with your device.
- Disconnect the power plug from AC outlet if the product is not going to be used for an extended period of time.

Don't :

- Do not use abrasive cleaners, waxes or solvents for your cleaning.
- Do not operate the product under the following conditions:
 - Extremely hot, cold or humid environment.
 - Areas susceptible to excessive dust and dirt.
 - Near any appliance generating a strong magnetic field.

Avis d'utilisation



Mise en garde — Pour prévenir les risques d'incendie ou d'électrocution, ne pas exposer le produit à l'humidité.



Mise en garde — Prière de ne pas ouvrir ou démonter le produit, car cela pourrait entraîner l'électrocution.



Mise en garde – Le cordon d'alimentation doit être branché à une prise pourvue d'une mise à la terre.



Mise en garde – La gaine du câble ne doit pas être retirée en conditions normales d'utilisation.



Mise en garde — Risque de renversement. Le moniteur tactile peut se renverser et causer de graves blessures corporelles, voire la mort. Pour prévenir les blessures, ce moniteur tactile doit être solidement fixé au mur selon les instructions d'installation.

Précautions

Veillez suivre toutes les mises en garde, précautions et entretiens recommandés dans ce manuel d'utilisation pour maximiser la durée de vie de votre unité.

À faire :

- Éteindre l'appareil avant de le nettoyer.
- Utiliser un chiffon humidifié par une solution savonneuse pour nettoyer le boîtier du produit.
- Utiliser uniquement l'adaptateur d'alimentation prescrit pour votre appareil.
- Débrancher l'appareil lorsqu'il n'est pas utilisé pendant une période prolongée.

À éviter :

- Ne pas utiliser de nettoyeurs abrasifs, de cires ou de solvants pour le nettoyage
- Ne jamais utiliser l'appareil dans les conditions suivantes :
 - des conditions environnementales extrêmes (chaud, froid ou humidité)
 - des endroits remplis de poussières et de saletés.
 - à proximité d'appareils produisant un fort champ magnétique.

Table of Contents

Chapter 1	7
1.1 Overview	8
1.2 Feature	8
1.3 Specifications	8
1.4 Block Diagram	9
1.5 Interface Connectors	10
1.5.1 Power Connector	10
1.5.2 Video Signal Connector	10
1.6 Package Overview	12
Chapter 2	13
2.1 About VESA Mount	14
2.2 About Wall Mount	15
2.2.1 Landscape	15
2.2.2 Portrait	17
2.2.3 Face up	18
2.3 On-Screen Display	19
2.3.1 OSD Function Description	21
2.3.2 Timing Table Chart	22
2.3.3 EDID Data	22
2.4 Dimension	23
2.4.1 Front View	23
2.4.2 Side View	23
2.4.3 Rear View	24
Appendix	25

Chapter 1

Product Introduction

1.1 Overview

The OF-150P-B1 series is a 15" touchscreen monitor that builds to withstand commercial grade open frame monitor, with stylish thin cable management bracket and versatile design OF-150P-B1 is an exceptional choice for applications for all business sectors and well suited for point-of-sales, point-of-information, point-of-service and interactive signage.

1.2 Feature

- Cable management bracket design for easy organize cable.

1.3 Specifications

LCD Touch Panel	
Size	15" TFT LCD
Brightness	350 cd/m ² (Non-touch screen) 315 cd/m ² (P-CAP)
Number of Pixels	1024 (H) x 768 (V)
Touch Type	P-CAP/ 10 points
Environment	
Certificate	CE 、 FCC
Compliance	IPX0
Operating Temperature	0°C ~ 50°C
Storage Temperature	-20°C ~ 60°C
Operating Humidity	10% ~ 95% RH, non-condensing
Mounting	VESA 100 mm x 100 mm
Dimension (W x H x D)	290.93 mm x 364.03 mm x 41.35 mm
Net Weight	2.98 kg
Gross Weight	4.25 kg

1.4 Block Diagram

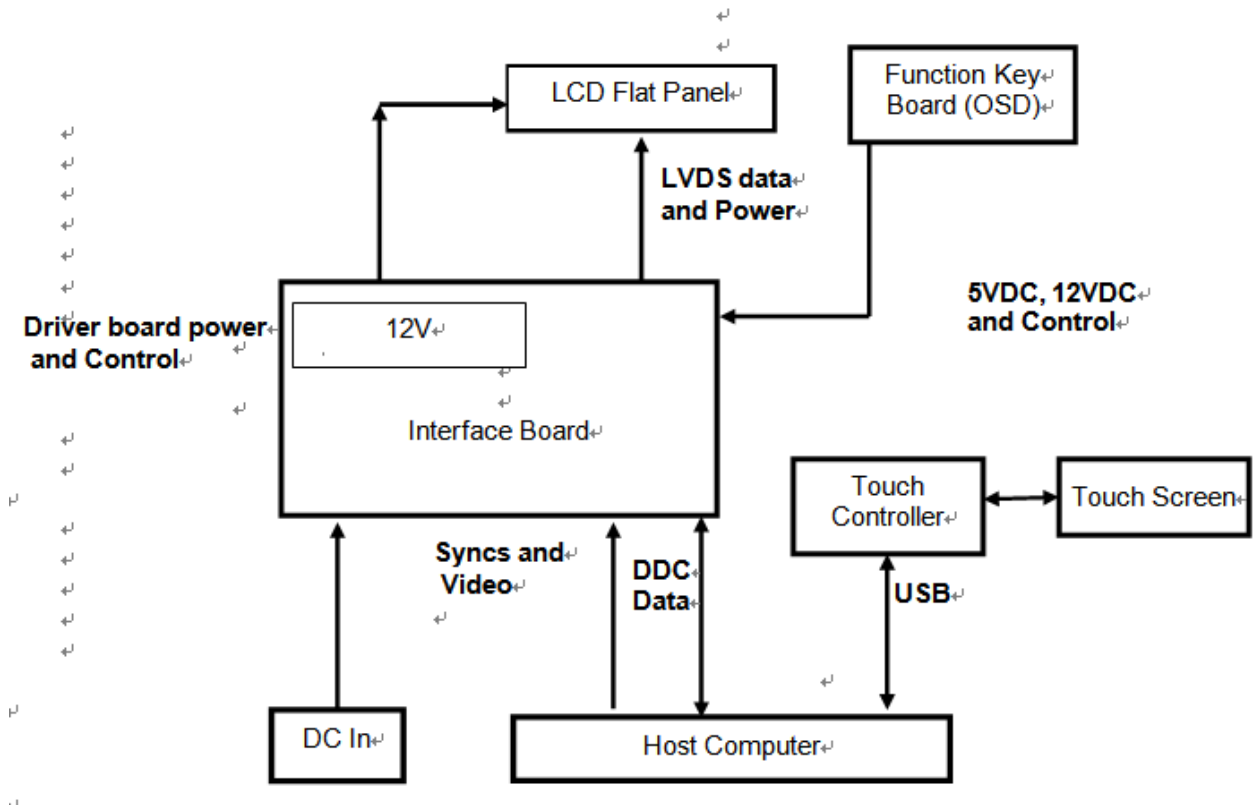

1.5 Interface Connectors



1.5.1 Power Connector

The AC/DC converter shall have an IEC320 type male power receptacle for connection to AC mains power. The power cord, exact type to be supplied in the appropriate Option Kit, shall be length of 1.8 ± 0.05 meters, and PC99 compliant.

1.5.2 Video Signal Connector

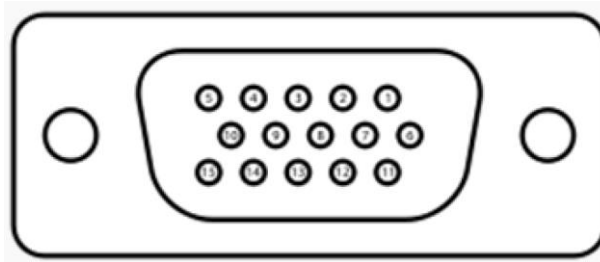

The video signal input via D-type 15-pin female connector.
Connector Pin Assignment:

Pin	Signal
1	Red video signal input
2	Green video signal input
3	Blue video signal input
4	NC
5	DDC ground for the VESA DDC2B function
6	Analog signal ground for the red video
7	Analog signal ground for the Green video
8	Analog signal ground for the blue video
9	+ 5V: Input from host system for the VESA DDC2B function
10	Signal ground
11	NC
12	SDA signal input for the VESA DDC2B function
13	Horizontal signal input from host system
14	Vertical signal input from host system
15	SCL signal input for the VESA DDC2B function

Display Port (1.1a)

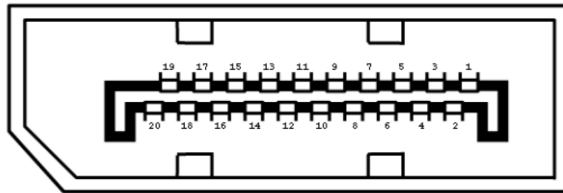

Pin	Signal	Pin	Signal
1	ML_Lane 0(p) Data0 +	11	Signal ground
2	Signal ground	12	ML_Lane 3(n) Data3 -
3	ML_Lane 0(n) Data0 -	13	Signal ground
4	ML_Lane 1(p) Data1 +	14	Signal ground
5	Signal ground	15	AUX_CH(p) AUX + Signal for Auxiliary Channel
6	ML_Lane 1(n) Data1 -	16	Signal ground
7	ML_Lane 2(p) Data2 +	17	AUX_CH(n) AUX - Signal for Auxiliary Channel
8	Signal ground	18	Hot Plug
9	ML_Lane 2(n) Data 2 -	19	DP_PWR Return
10	ML_Lane 3(p) Data3 +	20	DP_PWR

HDMI (1.3a)

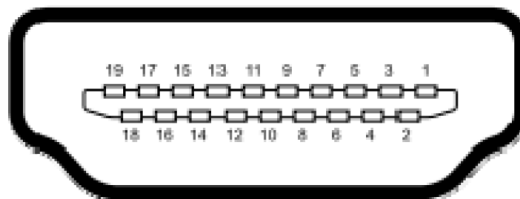

Pin	Signal	Pin	Signal
1	TMDS Data2+	11	TMDS Clock Shield
2	TMDS Data2 Shield	12	TMDS Clock-
3	TMDS Data2-	13	CEC
4	TMDS Data1+	14	Reserved (N.C. on device)
5	TMDS Data1 Shield	15	SCL
6	TMDS Data1-	16	SDA
7	TMDS Data0+	17	DDC/CEC Ground
8	TMDS Data0 Shield	18	+5V Power
9	TMDS Data0-	19	Hot Plug Detect

1.6 Package Overview

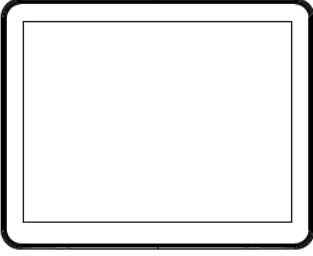
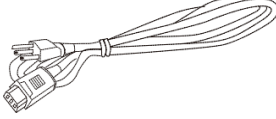
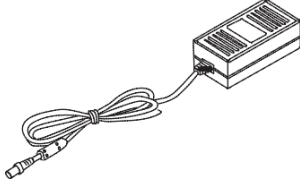
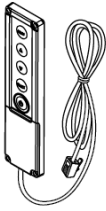
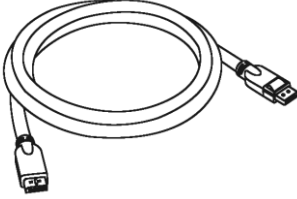
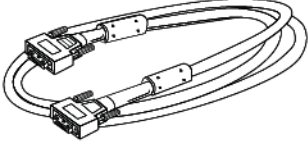
		
LCD Display	Power Cord	DC Power Supply
		
OSD Key pad	DP cable	VGA cable

Warning!

This product is intended to be supplied by a Listed Power Adapter or DC power source, rated 12Vdc, 1.5A minimum, Tma = 50 degree C minimum, and the altitude of operation = 3048m minimum. If it needs further assistance with purchasing the power source, please contact to MicroTouch for further information.

Mise en garde!

Cet appareil est conçu avec une alimentation de courant CA, d'une tension nominale de 12Vdc, 1.5A minimum, Tma = 50 degrés C minimum et l'altitude de l'utilisation = 3048 m minimum. Pour d'autres conseils pour l'installation de la source d'alimentation, communiquer avec MicroTouch pour de plus amples renseignements.

Chapter 2

Product Installation

2.1 About VESA Mount

The OF-150P-B1 series conform to the “VESA Flat Display Mounting Interface Standard” which defines a physical mounting interface for touch monitor, and corresponding with the standards of touch monitor mounting devices. The VESA mount is located on the back of this unit.

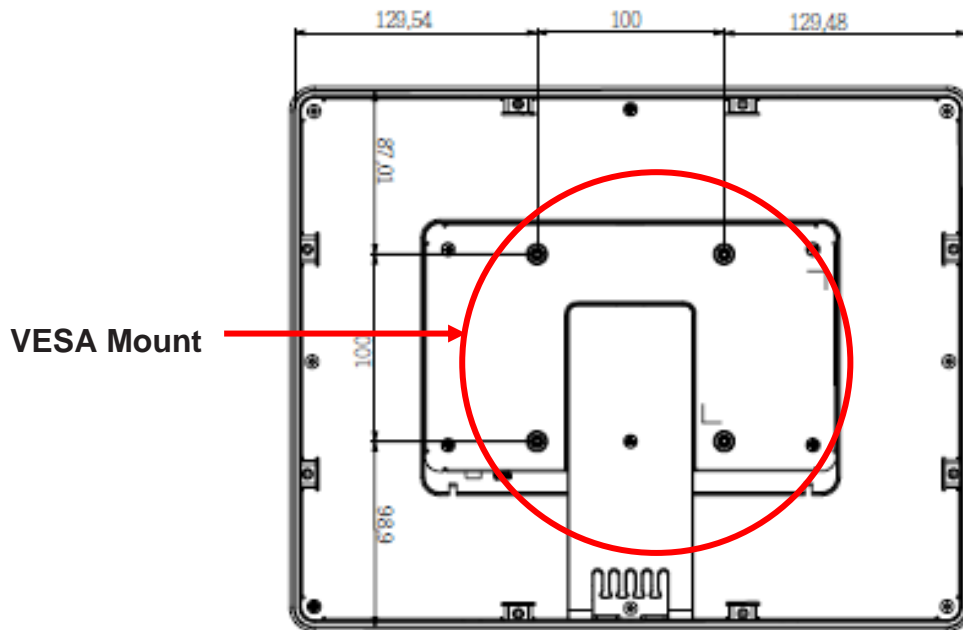

Warning!

*Please select the MicroTouch original screws!
The distance between the back cover surface and the bottom of the screw hole is 8 mm. Please use four M4 screws diameter with 8-10mm proper length to mount your monitor.*

Note: The mounting stand must be able to support at least 7.67 lbs (3.48 Kg).

Mise en garde!

*Sélectionner les vis d'origine de MicroTouch!
La distance entre la surface du couvercle arrière et le bas de l'orifice de la vis est de 8 mm et 18mm. Utiliser les vis M4 de diamètre pour le montage de votre moniteur.*

Remarque : Le support de montage doit pouvoir supporter un poids d'au moins 7.67 lb (3.48kg).

2.2 About Wall Mount

The OF-150P-B1 series support wall mount, and this monitor can be mounted to the wooden or concrete wall with 8xM4 screws diameter with 6mm length and two bracket set on the opposites.

2.2.1 Landscape

Depending on your mounting scheme, alternately, you may use the side brackets to mount your displays onto your wall or device.

Find a suitable location for attaching side brackets.

A. The left and right sides

B. The Top and bottom sides

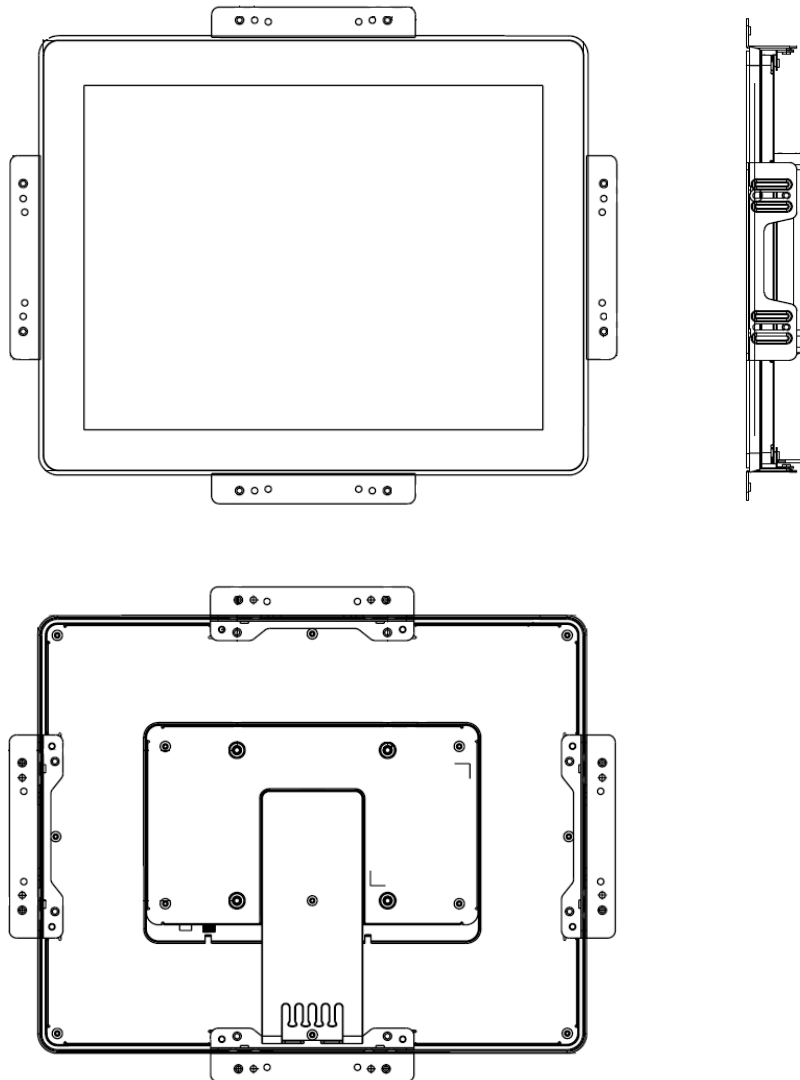



Warning!

This apparatus is intended to be supported by a Listed Wall Mount Bracket” or the equivalent.



Mise en garde!

Cet appareil est conçu pour être supporté par un support de fixation mural répertorié ”ou l’équivalent.

2.2.2 Portrait

- A. The left and right sides
- B. The Top and bottom sides

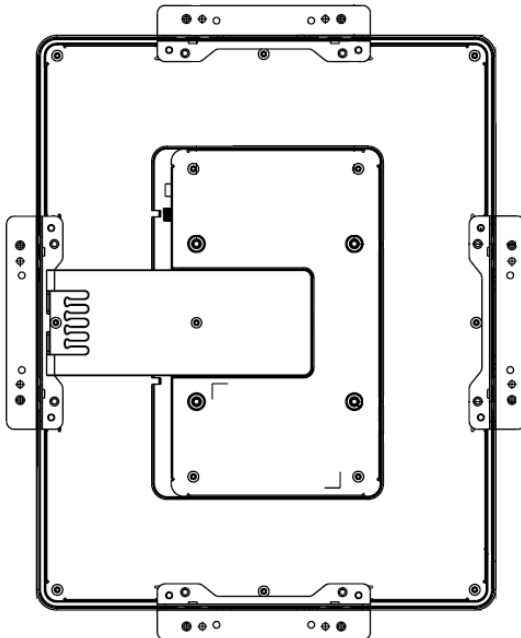
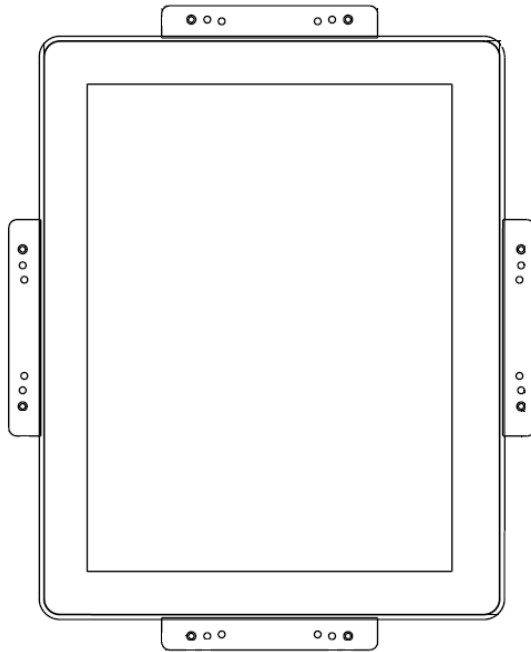

2.2.3 Face up

Step1: To install bracket on customer's cabinet.

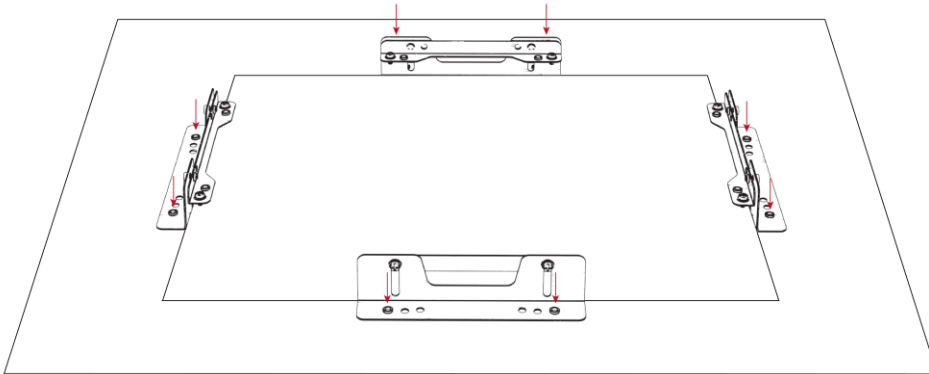

Back side

Step2: Assembly OF-150P-B1 into the cabinet and insert screws.

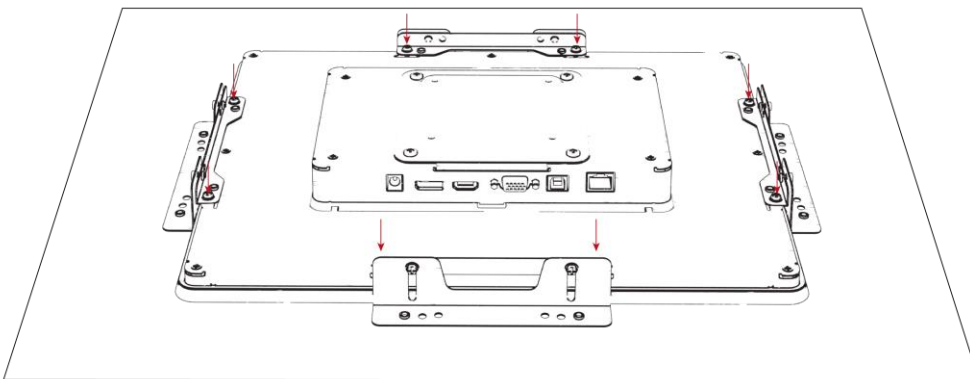

Back side

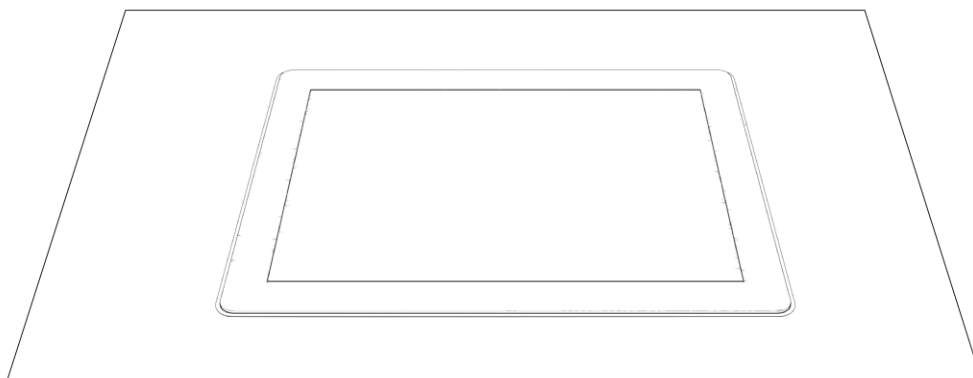

Front side

2.3 On-Screen Display



The OF-150P-B1 series provide RJ45 port for connecting with OSD remote key. And the following is OSD key function table:

Key \ OSD	Menu off status	Menu on status
☰	Menu appear	Menu disappear/ return to main item
▲	Brightness	Main item select up/ Adjust up
▼	Contrast	Main item select down/ Adjust down
↵	Enter/Select sub-item function	
⏻	Power On/Off	

1. Press the “MENU” button to pop up the “on-screen menu” and press “Up” or “Down” button to select among the five functions in the main menu.
2. Choose the adjustment items by pressing the “Enter” button.
3. Adjust the value of the adjustment items by pressing the “Up” or “Down” button.
4. With the OSD menu on screen, press “Menu” button to return main menu or exit OSD.
5. The OSD menu will automatically close, if you have left it idle for a pre-set time.
6. To Lock the OSD / Power menu buttons, please follow the instructions below.

(Please note: the monitor has to be turned ON with a valid signal pre-set)

- a. Press “Menu” key, the OSD menu will pops upon display.
- b. Press and hold the “Menu” key again with the OSD menu on the screen, the OSD menu will disappear. Then press the "Power" key 1 time while the menu key is still being pressed. The “Lock/Unlock” menu will appear for 3 seconds.

- c. Use the "Enter" key to select OSD or Power setting then set at "Lock" by pushing the "UP" or "Down" button.
 - d. When the "UP" or "Down" button is released, the previous setting will be saved and exit the "Lock/Unlock" menu automatically.
7. To Unlock the OSD / Power menu buttons, please follow the instructions below.(Please note: the monitor has to be turned ON with a valid signal pre-set)Press and hold the "Menu" key then
 - a. Press the "Power" key simultaneously, the "Lock/ Unlock" menu will appear for 3 seconds.
 - b. Use the "Enter" key to select OSD or Power setting then set at "Unlock" by pushing the "UP" or "Down" button.
 - c. When the "UP" or "Down" button is released, the previous setting will be saved and exit the "Lock/Unlock" menu automatically.

Please note:

1. When the OSD Lock function is selected, this indicates that all the buttons except "power" button are now disabled.
2. When the Power Lock function is selected, this indicates that the power key is disabled; user can not to turn off the monitor by "Power" key.

2.3.1 OSD Function Description

Item	Content	Default
Contrast	The monitor luminance level control.	50
Brightness	The monitor backlight level control.	100
Auto Adjust	Fine-tune the image to full screen automatically.	NA
Left/Right	Moving screen image horizontal position to left or right.	NA
Up/Down	Moving screen image vertical position to up or down.	NA
Horizontal size	The screen image horizontal dot clock adjustment.	NA
Fine	The screen image pixel phase adjustment.	NA
OSD Left/Right	Moving OSD menu horizontal position to left or right.	50
OSD Up/Down	Moving OSD menu vertical position to up or down.	50
OSD Time out	OSD auto-disappear time selection.	15
OSD Language	OSD menu language selection. (English, French, Japanese, Deutsch, Spanish, Italian, Traditional Chinese and Simplified Chinese)	English
Factory Reset	Factory default value restored.	NA
RGB	Color temperature selection. (9300K, 6500K, 5500K, 7500K, User)	USER

2.3.2 Timing Table Chart

Mode	NO	Resolution	H-Freq. (KHz)	Band Width (MHz)	Polarity	
					H	V
1	102	720x400 70Hz	31.47	28.322	-	+
2	103	VGA 640x480 60Hz	31.47	25.175	-	-
3	182	MAC 640x480 66Hz	35	30.24	-	-
4	173	640x480 72Hz	37.86	31.5	-	-
5	109	640X480 75Hz	37.5	31.5	-	-
6	104	800x600 56Hz	35.16	36	+	+
7	116	800x600 60Hz	37.88	40	+	+
8	110	800x600 72Hz	48.077	50	+	+
9	117	800x600 75Hz	46.875	49.5	+	+
10	108	832x624 (74.55Hz)	49.722	57.28	-	-
11	118	1024x768 (60.0 Hz)	48.363	65	-	-
12	157	1024x768 (70.0 Hz)	56.476	75	-	-
13	141	1024x768 (75.0 Hz)	60.02	78.75	+	+

Note: If input H-display > 1024 pixel or V-display > 768 lines or V-Sync >76Hz, then OSD shall display warning out of range.

2.3.3 EDID Data

DP/HDMI

The monitor assembly shall provide a display communications channel that conforms to VESA DDC2B hardware requirements. This configuration shall contain the 256-byte EDID file as specified by VESA EDID Standard.

VGA

The monitor assembly shall provide a display communications channel that conforms to VESA DDC2B hardware requirements. This configuration shall contain the 128-byte EDID file as specified by VESA EDID Standard.

2.4 Dimension

2.4.1 Front View

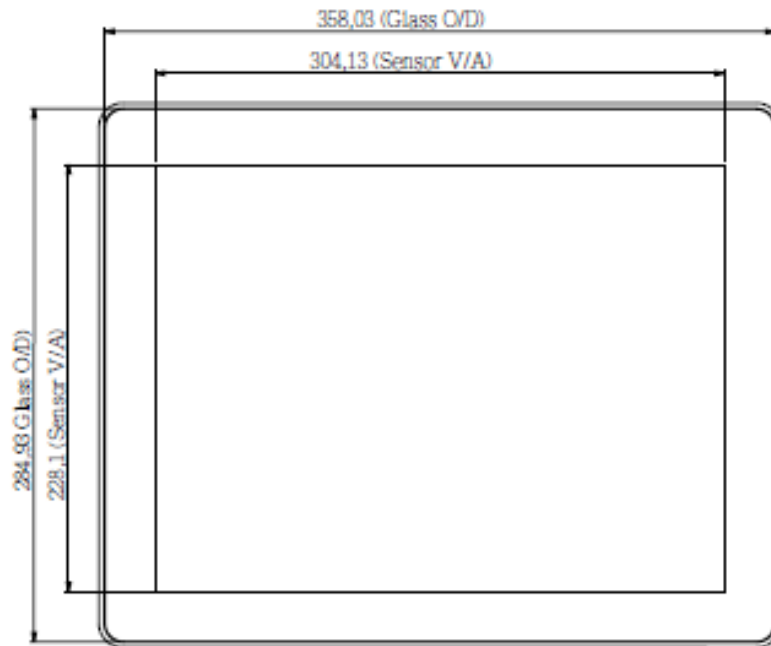

2.4.2 Side View

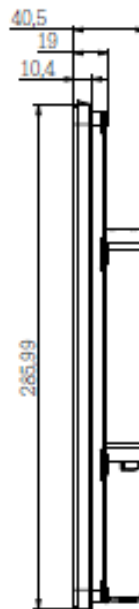

2.4.3 Rear View

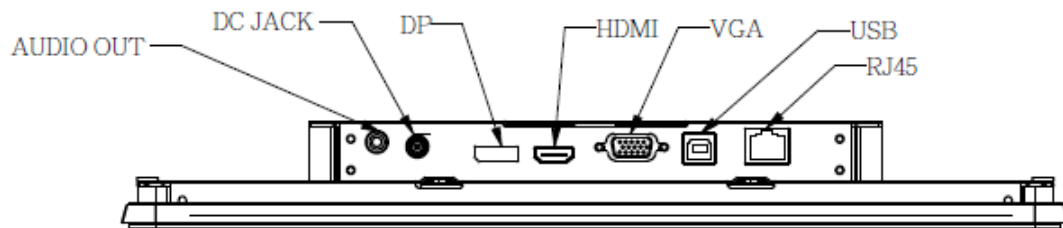
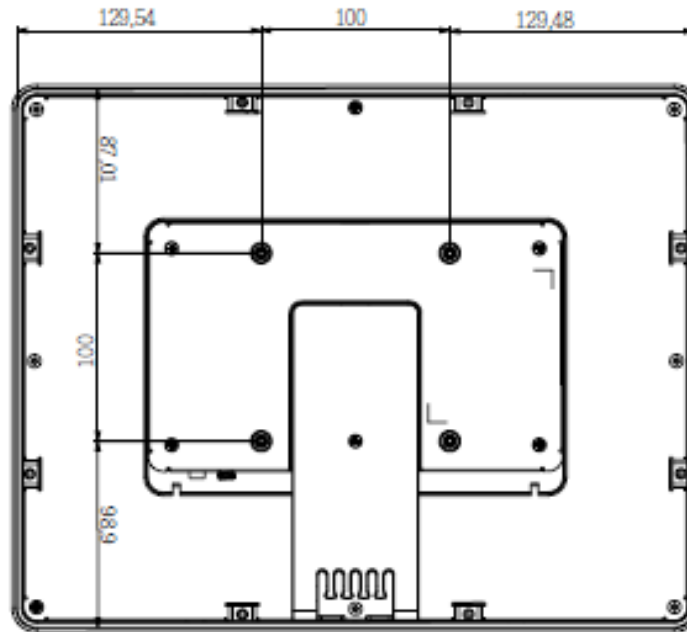

Appendix

Declaration of the Presence Condition of the Restricted Substances Marking

設備名稱：觸控螢幕 Equipment name : Touch LCD Monitor		型號（型式）：OF-150P-B1 Type designation (Type) : OF-150P-B1				
單元 Unit	限用物質及其化學符號 Restricted substances and its chemical symbols					
	鉛 Lead (Pb)	汞 Mercury (Hg)	鎘 Cadmium (Cd)	六價鉻 Hexavalent chromium (Cr ⁺⁶)	多溴聯苯 Polybrominated biphenyls (PBB)	多溴二苯醚 Polybrominated diphenyl ethers (PBDE)
塑膠零件 Plastic Parts	○	○	○	○	○	○
金屬零件 Metal Parts	-	○	○	○	○	○
線纜和電纜組件 Cable component	-	○	○	○	○	○
LCD 面板 LCD Panel	-	○	○	○	○	○
觸控式螢幕面板 Touch Panel	-	○	○	○	○	○
PCBA	-	○	○	○	○	○
軟體(CD 等) Software	○	○	○	○	○	○
<p>Note 1 : “Exceeding 0.1 wt %” and “exceeding 0.01 wt %” indicate that the percentage content of the restricted substance exceeds the reference percentage value of presence condition. °</p> <p>Note 2 : “○” indicates that the percentage content of the restricted substance does not exceed the percentage of reference value of presence.</p> <p>Note 3 : The “-” indicates that the restricted substance corresponds to the exemption.</p>						